

# beko

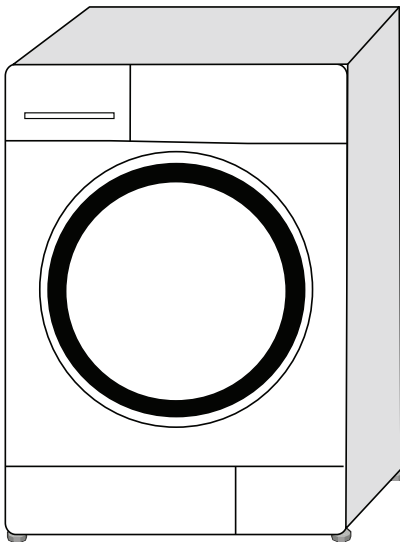

## Washing Machine User's Manual

WMB 714422 W



# Please read this user manual first!





Dear Customer,

Thank you for preferring a Beko product. We hope that you get the best results from your product which has been manufactured with high quality and state-of-the-art technology. Therefore, please read this entire user manual and all other accompanying documents carefully before using the product and keep it as a reference for future use. If you handover the product to someone else, give the user manual as well. Follow all warnings and information in the user manual.

Remember that this user manual is also applicable for several other models. Differences between models will be identified in the manual.

## Explanation of symbols

Throughout this user manual the following symbols are used:

	Important information or useful hints about usage.
	Warning for hazardous situations with regard to life and property.
	Warning for electric shock.
	Recyclable materials.

Do not dispose of the packaging materials together with the domestic or other wastes. Take them to the packaging material collection points designated by the local authorities.



---

This product was manufactured using the latest technology in environmentally friendly conditions.

# TABLE OF CONTENTS

<b>1 General safety instructions</b>	<b>5</b>
1.1 Life and property safety	5
1.2 Children's safety	6
1.3 Electrical safety	7
1.4 Hot surface safety	7
<b>2 Important instructions for environment</b>	<b>8</b>
2.1 Compliance with WEEE Directive	8
2.2 Package information	8
<b>3 Intended use</b>	<b>8</b>
<b>4 Your product</b>	<b>9</b>
4.1 Overview	9
4.2 Package Contents	10
4.3 Technical specifications	11
4.4 Installation	12
4.4.1 Appropriate installation location	12
4.4.2 Removing packaging reinforcement	13
4.4.3 Removing the transportation locks	13
4.4.4 Connecting water supply	14
4.4.5 Connecting the drain hose to the drain	15
4.4.6 Adjusting the feet	16
4.4.7 Electrical connection	16
4.4.8 Initial use	17
4.5 Preparation	18
4.5.1 Sorting the laundry	18
4.5.2 Preparing laundry for washing	19
4.5.3 Things to be done for energy saving	19
4.5.4 Loading the laundry	20
4.5.5 Correct load capacity	20
4.5.6 Using detergent and softener	20
4.5.7 Tips for efficient washing	23
4.6 Operating the product	24
4.6.1 Control panel	24
4.6.2 Display symbols	24
4.6.3 Preparing the machine	25
4.6.4 Programme selection	25
4.6.5 Programmes	25
4.6.6 Temperature selection	27
4.6.7 Economy symbol	27
4.6.8 Spin speed selection	27
4.6.9 Programme and consumption table	28
4.6.10 Auxiliary function selection	29

## TABLE OF CONTENTS

4.6.11 Time display -----	30
4.6.12 Delayed start -----	31
4.6.13 Starting the programme -----	31
4.6.14 Progress of programme -----	32
4.6.15 Loading door lock -----	32
4.6.16 Changing the selections after programme has started -----	32
4.6.17 Child Lock -----	33
4.6.18 Cancelling the programme -----	34
4.6.19 Machine is in Rinse Hold mode -----	34
4.6.20 End of programme -----	34
4.6.21 Your machine is equipped with a "Standby Mode" -----	34
<b>4.7 Maintenance and cleaning -----</b>	<b>35</b>
4.7.1 Cleaning the detergent drawer -----	35
4.7.2 Cleaning the loading door and the drum -----	35
4.7.3 Cleaning the body and control panel -----	36
4.7.4 Cleaning the water intake filters -----	36
4.7.5 Draining remaining water and cleaning the pump filter -----	37

## 5 Troubleshooting

**39**

# 1 General safety instructions

This section includes security instructions which may help prevent the injuries and material damage risks. All kinds of warranties shall be invalid if these instructions are not observed.

## 1.1 Life and property safety

- ▶ Never place the product on a carpet-covered floor. Electrical parts will get overheated since air cannot circulate from under the device. This will cause problems with your product.
- ▶ Unplug the product if it is not in use.
- ▶ Always have the installation and repairing procedures carried out by the Authorized Service Agent. Manufacturer shall not be held liable for damages that may arise from procedures carried out by unauthorized persons.
- ▶ The water supply and draining hoses must be securely fastened and remain undamaged. Otherwise, water leak may occur.
- ▶ While there is still water inside the product, never open the loading door or remove the filter. Otherwise, risk of flooding and injury from hot water will occur.
- ▶ Do not force open the locked loading door. Door can be opened a few minutes after the washing cycle ends. In case of forcing the loading door to open, the door and the lock mechanism may get damaged.
- ▶ Use detergents, softeners and supplements suitable for automatic washing machines only.
- ▶ Follow the instructions on the label of textiles and the detergent package.

## 1.2 Children's safety

- ▶ This product can be used by the children who are at the age of 8 and over and the people whose physical, sensory or mental skills are not fully developed or who do not have necessary required experience and knowledge as long as they are supervised or trained about the safe use of the product and its risks. Children should not play with the device. Cleaning and maintenance works should not be performed by children unless they are supervised by someone. Children of less than 3 years should be kept away unless continuously supervised.
- ▶ Packaging materials may be dangerous for the children. Keep packaging materials in a safe place away from reach of the children.
- ▶ Electrical products are dangerous for the children. Keep the children away from the product when it is in use. Do not allow them to play with the product. Use child lock to prevent children from intervening with the product.
- ▶ Do not forget to close the loading door when leaving the room where the product is located.
- ▶ store all detergents and additives in a safe place away from the reach of the children by closing the cover of the detergent container or sealing the detergent package.

## 1.3 Electrical safety

- ▶ If the product has a failure, it should not be operated unless it is repaired by the Authorized Service Agent. Risk of electric shock!
- ▶ This product is designed to resume operating in the event of powering on after a power interruption. If you wish to cancel the programme, see "Cancelling the programme" section.
- ▶ Plug the product into a grounded outlet protected by a 13 A fuse. Do not neglect to have the grounding installation made by a qualified electrician. Our company shall not be liable for any damages that will arise when the product is used without grounding in accordance with the local regulations.
- ▶ Do not wash the product by spraying or pouring water onto it! Risk of electric shock!
- ▶ Never touch the power cable plug with wet hands! Do not grab the power cord to unplug the machine, always unplug it by holding the socket with one hand, and pulling the plug with the other hand.
- ▶ Product should be unplugged during installation, maintenance, cleaning and repair procedures.
- ▶ If the power cable is damaged, it must be replaced by the manufacturer, after sales service or a similarly qualified person (preferably an electrician) or someone designated by the importer in order to avoid possible risks.

## 1.4 Hot surface safety

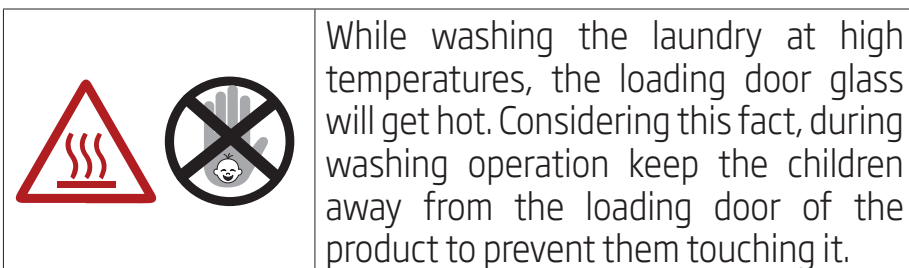

## 2 Important instructions for environment

### 2.1 Compliance with WEEE Directive



This product complies with EU WEEE Directive (2012/19/EU). This product bears a classification symbol for waste electrical and electronic equipment (WEEE).

This product has been manufactured with high quality parts and materials which can be reused and are suitable for recycling. Do not dispose of the waste product with normal domestic and other wastes at the end of its service life. Take it to the collection center for the recycling of electrical and electronic equipment. Please consult your local authorities to learn about these collection centers.

Compliance with RoHS Directive:

The product you have purchased complies with EU RoHS Directive (2011/65/EU). It does not contain harmful and prohibited materials specified in the Directive.

### 2.2 Package information

Packaging materials of the product are manufactured from recyclable materials in accordance with our National Environment Regulations. Do not dispose of the packaging materials together with the domestic or other wastes. Take them to the packaging material collection points designated by the local authorities.

## 3 Intended use

- This product has been designed for domestic use. It is not for commercial purposes or it should not be used out of its intended use.
- The product must only be used for washing and rinsing of laundry that are marked accordingly.
- The manufacturer waives any responsibility arisen from incorrect usage or transportation.
- The service life of your product is 10 years. During this period, original spare parts will be available to operate the appliance properly.

## 4 Your product

### 4.1 Overview

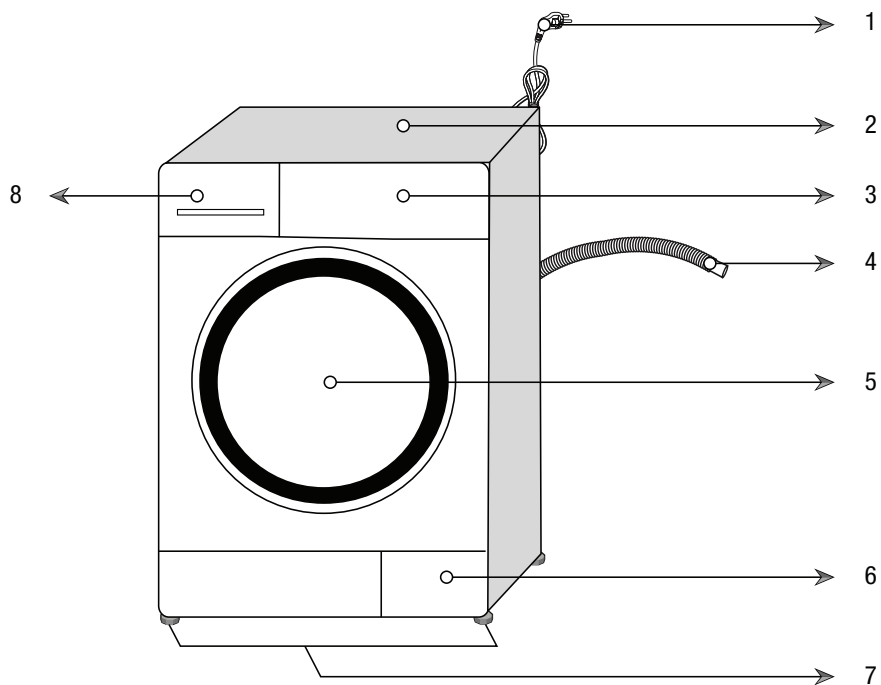

- 1- Power cable
- 2- Top panel
- 3- Control panel
- 4- Drain hose
- 5- Loading door
- 6- Filter cap
- 7- Adjustable feet
- 8- Detergent drawer

## 4.2 Package Contents

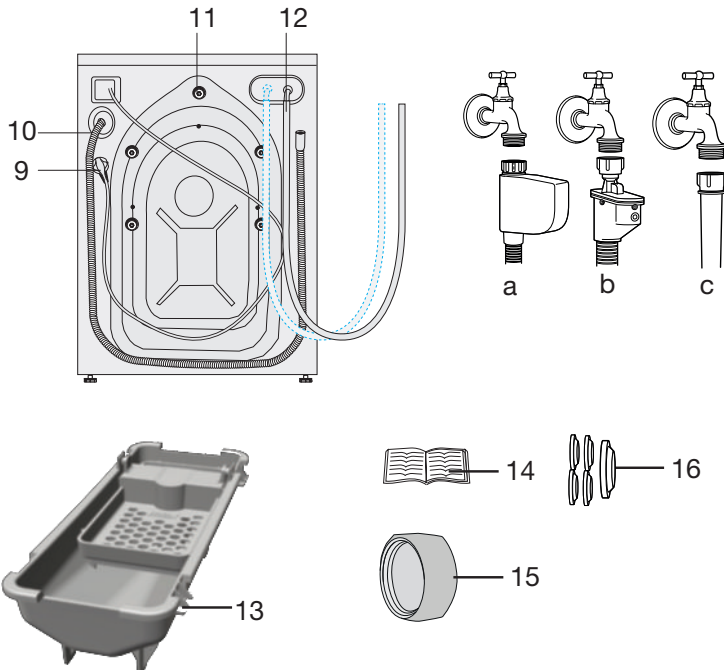

- 9- Power cable
  - 10- Drain hose
  - 11- Transportation safety bolts\*
  - 12- Mains water inlet hose (One of the following filter types is used for the mains hose connection.)
    - a- Electronic water shut-off
    - b- Mechanical water shut-off
    - c- Standard
  - 13- Liquid detergent container\*\*
  - 14- User Manual
  - 15- Blind plug\*\*\*
  - 16- Plastic plug group
- \* Number of transportation safety bolts may change depending on the model of your product.  
\*\* This may be supplied with the machine depending on the model of your product.  
\*\*\* It will be supplied if your product has double water inlet.

C

Figures in this manual are schematic and may not match the product exactly.

## 4.3 Technical specifications

### Complying Commission Delegated Regulation (EU) No 1061/2010

Supplier name or trademark	Beko
Model name	WMB714422W
Rated capacity (kg)	7
Energy efficiency class / Scale from A+++ (Highest Efficiency) to D (Lowest Efficiency)	A++
Annual Energy Consumption (kWh) <sup>(1)</sup>	196
Energy consumption of the standard 60°C cotton programme at full load (kWh)	1.001
Energy consumption of the standard 60°C cotton programme at partial load (kWh)	0.767
Energy consumption of the standard 40°C cotton programme at partial load (kWh)	0.747
Power consumption in 'off-mode' (W)	0.200
Power consumption in 'left-on mode' (W)	1.000
Annual Water Consumption (l) <sup>(2)</sup>	9460
Spin-drying efficiency class / Scale from A (Highest Efficiency) to G (Lowest Efficiency)	B
Maximum spin speed (rpm)	1400
Remaining moisture Content (%)	53
Standard cotton programme <sup>(3)</sup>	Cotton Eco 60°C and 40°C
Programme time of the standard 60°C cotton programme at full load (min)	176
Programme time of the standard 60°C cotton programme at partial load (min)	151
Programme time of the standard 40°C cotton programme at partial load (min)	151
Duration of the left-on mode (min)	N/A
Airborne acoustical noise emissions washing/spinning (dB)	58/76
Built-in	No
Rated capacity (kg)	7
Height (cm)	84
Width (cm)	60
Depth (cm)	50
Net weight (± 4 kg.)	70
Single Water inlet / Double Water inlet	• / -
• Available	
Electrical input (V/Hz)	230 V / 50Hz
Total current (A)	10
Total power (W)	2200
Main model code	8810

<sup>(1)</sup> Energy Consumption based on 220 standard washing cycles for cotton programmes at 60°C and 40°C at full and partial load, and the consumption of the low-power modes. Actual energy consumption will depend on how the appliance is used.

<sup>(2)</sup> Water consumption based on 220 standard washing cycles for cotton programmes at 60°C and 40°C at full and partial load. Actual water consumption will depend on how the appliance is used.

<sup>(3)</sup> „Standard 60°C cotton programme“ and the „standard 40°C cotton programme“ are the standard washing programmes to which the information in the label and the fiche relates and these programmes are suitable to clean normally soiled cotton laundry and that they are the most efficient programmes in terms of combined energy and water consumption.

Technical specifications may be changed without prior notice to improve the quality of the product.

## **4.4 Installation**

- Apply to the nearest authorized service agent for the installation of your product.
- Preparation of the location and electrical, tap water and waste water installations at the place of installation is under customer's responsibility.
- Make sure that the water inlet and discharge hoses as well as the power cable are not folded, pinched or crushed while pushing the product into its place after installation or cleaning procedures.
- Make sure that the installation and electrical connections of the product are performed by authorized service. Manufacturer shall not be held liable for damages that may arise from procedures carried out by unauthorized persons.
- Prior to installation, visually check if the product has any defects on it. If so, do not have it installed. Damaged products cause risks for your safety.

### **4.4.1 Appropriate installation location**

- Place the product on a hard and level floor. Do not put it onto a carpet with high pile or other similar surfaces.
- When the washing machine and drier are placed on top of each other, their total weight -when loaded- amounts to 180 kilograms. Place the product on a solid and flat floor that has sufficient load carrying capacity!
- Do not place the product on the power cable.
- Do not install the product in the environments where the temperature falls below 0 °C.
- Leave a minimum space of 1 cm between the machine and the furniture.
- On a graduated floor, do not place the product next to the edge or on a platform.

## 4.4.2 Removing packaging reinforcement



Tilt the machine backwards to remove the packaging reinforcement. Remove the packaging reinforcement by pulling the ribbon. Do not make this operation alone by yourself.

## 4.4.3 Removing the transportation locks

- 1 Loosen all bolts with an appropriate wrench until they turn freely **(C)**.
- 2 Remove the transport safety bolts by turning them slightly.
- 3 Insert the plastic covers in the bag containing the user manual to the openings on the rear panel. **(P)**

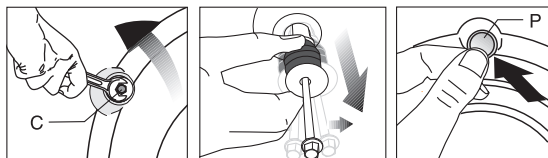

**A**

**CAUTION:** Remove the transportation safety bolts before operating the washing machine! Otherwise, the product will be damaged.

**C**

Keep the transportation safety bolts in a safe place to reuse when the washing machine needs to be moved again in the future.

Install the transport safety bolts in reverse order of the disassembly procedure.

Never move the product without the transportation safety bolts properly fixed in place!

## 4.4.4 Connecting water supply

<b>C</b>	<p>The water supply pressure required to run the product is between 1 to 10 bars (0.1 - 1 MPa). It is necessary to have 10 - 80 liters of water flowing from the fully open tap in one minute to have your machine run smoothly. Attach a pressure reducing valve if water pressure is higher.</p> <p>If you are going to use the double water-inlet product as a single (cold) water-inlet unit, you must install the supplied stopper to the hot water valve before operating the product. (Applies for the products supplied with a blind stopper group.)</p>
<b>A</b>	<p><b>CAUTION:</b> Models with a single water inlet should not be connected to the hot water tap. In such a case the laundry will get damaged or the product will switch to protection mode and will not operate.</p>
	<p><b>CAUTION:</b> Do not use old or used water inlet hoses on the new product. It may cause stains on your laundry.</p>

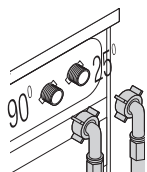

Connect the special water supply hoses supplied with the product to the water inlets on the product. Red hose (left) (max. 90 °C) is for hot water inlet, blue hose (right) (max. 25 °C) is for cold water inlet.

Make sure that the hot and cold water taps are connected correctly when the product is being installed. Otherwise, your laundry will come out hot at the end of the washing process and wear out.

- 1 Tighten the nuts of the hose by hand. Never use a tool when tightening the nuts.
- 2 When hose connection is completed, check whether there is leak problems at the connection points by opening the taps fully. If any leaks occur, turn off the tap and remove the nut. Retighten the nut carefully after checking the seal. In order to prevent the water leaks and resultant damages, keep the taps closed when you do not use the product.

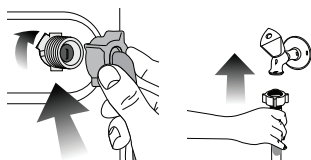

## 4.4.5 Connecting the drain hose to the drain

- Attach the end of the drain hose directly to waste water drain, lavatory or bathtub.

**A**

**CAUTION:** Your drain house will be flooded if the hose comes out of its housing during water discharge. Moreover, there is risk of scalding due to high washing temperatures! In order to prevent such situations and make sure that the machine performs water intake and discharge processes without any problem, fix the drain hose securely.

- Connect the drain hose to a minimum height of 40 cm and a maximum height of 100 cm.
- In case the drain hose is elevated after laying it on the floor level or close to the ground (less than 40 cm above the ground), water discharge becomes more difficult and the laundry may come out excessively wet. Therefore, follow the heights described in the figure.

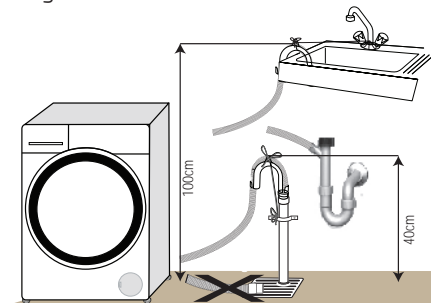

- To prevent the waste water to go back into the machine again and to ensure easy drainage, do not immerse the end of the hose into the waste water or do not insert it into the drain for more than 15 cm. If it is too long, cut it short.
- The end of the hose should not be bent, it should not be stepped on and the hose must not be pinched between the drain and the machine.
- If the length of the hose is too short, use it by adding an original extension hose. Length of the hose may not be longer than 3.2 m. To avoid water leak failures, the connection between the extension hose and the drain hose of the product must be fitted well with an appropriate clamp as not to come off and leak.

## 4.4.6 Adjusting the feet

# A

**CAUTION:** In order to ensure that the product operates more silently and vibration-free, it must stand level and balanced on its feet. Balance the machine by adjusting the feet. Otherwise, the product may move from its place and cause crushing and vibration problems.

**CAUTION:** Do not use any tools to loosen the lock nuts. Otherwise, they will get damaged.

- 1 Loosen the lock nuts on the feet by hand.
- 2 Adjust the feet until the product stands in a stable and balanced way.
- 3 Tighten all lock nuts by hand again.

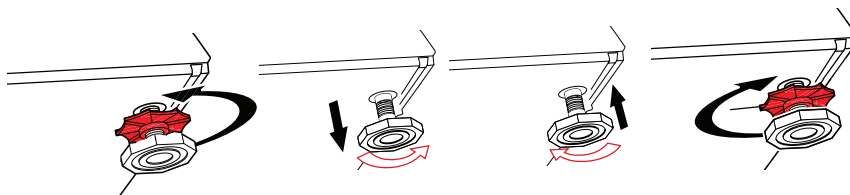

## 4.4.7 Electrical connection

Connect the product to a grounded outlet protected by a 13 A fuse. Our company shall not be liable for any damages that will arise when the product is used without grounding in accordance with the local regulations.

- Connection must comply with national regulations.
- Power cable plug must be within easy reach after installation.
- If the current value of the fuse or breaker in the house is less than 13 Amps, have a qualified electrician install a 13 Amp fuse.
- The voltage specified in the "Technical specifications" section must be equal to your mains voltage.
- Do not make connections via extension cables or multi-plugs.

# B

**WARNING:** Damaged power cables must be replaced by the Authorised Service Agents.

### Electrical requirements

Before you insert the plug into the wall socket make sure that the voltage and the frequency shown in the rating label corresponds to your electricity supply.

We recommend that this appliance be connected to the mains supply via a suitable switched and fused socket in a readily accessible position.

Should the mains lead of the appliance become damaged or need replacing at any time, it must be replaced by a special purpose made mains lead which can only be obtained from a Authorised Service Agent.

# B

**WARNING:** This appliance must be earthed

If the fitted moulded plug is not suitable for your socket, then the plug should be cut off and an appropriate plug fitted.

Destroy the old plug, which is cut off as a plug with a bared cord could cause a shock hazard if inserted into a socket elsewhere in the house.

The moulded plug on this appliance incorporates a 13A fuse. Should the fuse need to be replaced an ASTA approved BS1362 fuse of the same rating must be used. Do not forget to refit the fuse cover. In the event of losing the fuse cover, the plug must not be used until a replacement fuse cover has been fitted. Colour of the replacement fuse cover must be the same colour as that visible on the pin face of the plug. Fuse covers are available from any good electrical store.

### Important Fitting a different plug

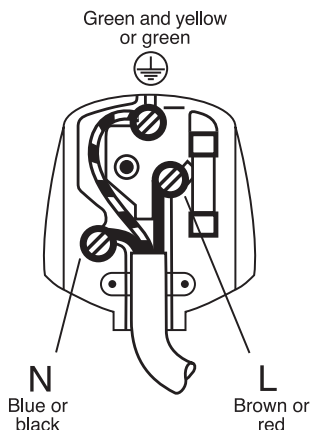

As the colours of the wires in the mains lead of this appliance may not correspond with the coloured markings identifying the terminals on your plug, proceed as follows:

- 1 Connect the green - yellow or green (earth) wire to the terminal in the plug marked 'E' or with the symbol  $\perp$  or coloured green and yellow or green.
- 2 Connect the blue (neutral) wire to the terminal in the plug marked 'N' or coloured black.
- 3 Connect the brown (live) wire to the terminal in the plug marked 'L' or coloured red.

With the alternative plugs a 13A fuse must be fitted either in the plug or adaptor or in the main fuse box. If in doubt contact a qualified electrician.

### Transportation of the product

1. Unplug the product before transporting it.
2. Remove water drain and water supply connections.
3. Drain all water that has remained in the product.
4. Install transportation safety bolts in the reverse order of removal procedure.

**C**

Never move the product without the transportation safety bolts properly fixed in place!

**A**

**WARNING:** Packaging materials are dangerous to children. Keep packaging materials in a safe place away from reach of the children.

#### 4.4.8 Initial use

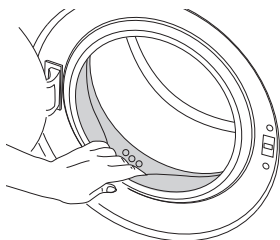

Before starting to use the product make sure that the preparations are made which are in line with the "Important Safety and Environment Instructions" and the instructions in the "Installation" section.

To prepare the product for washing laundry, perform first operation in Drum Cleaning programme. If this program is not available in your machine, apply the method which is described in the section 4.7.2.

**C**









































Use an anti-limescale suitable for the washing machines.

Some water might have remained in the product due to the quality control processes in the production. It is not harmful for the product.

## 4.5 Preparation

### 4.5.1 Sorting the laundry

- \* Sort laundry according to type of fabric, color, and degree of soiling and allowable water temperature.
- \* Always obey the instructions given on the garment tags.

LAUNDRY WASH SYMBOLS											
 <b>WASH</b>	Symbols for washing on machine										
	Water temperatures	Maximum	95°C	70°C	60°C	50°C	40°C	30°C			
	Symbol(s)										
 <b>DRYING</b>	Drying symbols										
	Drying settings										
 <b>IRON</b>	Iron										
	Dry or steam	Iron at high temperature	Iron at medium temperature	Iron at low temperature	No ironing	Iron without steam					
	Maximum temperature	200 °C	150 °C	110 °C							
 <b>BLEACH</b>											
		All bleaches are allowed	Bleach (sodium hypochlorite) can be used	Bleach is not allowed	Only bleaches without chlorine are allowed						

## 4.5.2 Preparing laundry for washing

- Laundry items with metal attachments such as, underwiring, belt buckles or metal buttons will damage the product. Remove the metal pieces or wash the clothes by putting them in a laundry bag or pillow case.
- Take out all substances in the pockets such as coins, pens and paper clips, and turn pockets inside out and brush. Such objects may damage the product or cause noise problem.
- Put small size clothes such as infant's socks and nylon stockings in a laundry bag or pillow case.
- Place curtains in without compressing them. Remove curtain attachment items.
- Fasten zippers, sew loose buttons and mend rips and tears.
- Wash "Machine washable" or "Hand washable" labeled products only with an appropriate programme.
- Do not wash colours and whites together. New, dark coloured cottons release a lot of dye. Wash them separately.
- Tough stains must be treated properly before washing. If unsure, check with a dry cleaner.
- Only use the dyes / color changers and descaling agents which are appropriate to machine wash. Always follow the instructions on the package.
- Wash trousers and delicate laundry turned inside out.
- Keep laundry items made of Angora wool in the freezer for a few hours before washing. This will reduce pilling.
- Laundry that are subjected to materials such as flour, lime dust, milk powder, etc. intensely must be shaken off before placing into the product. Such dusts and powders on the laundry may build up on the inner parts of the product in time and can cause damage.

## 4.5.3 Things to be done for energy saving

Following information will help you use the product in an ecological and energy-efficient manner.

- Operate the product in the highest load capacity allowed for the programme you have selected, but do not overload. See, "Programme and consumption table".
- Always follow the instructions on the detergent packaging.
- Wash slightly soiled laundry at low temperatures.
- Use faster programmes for small quantities of lightly soiled laundry.
- Do not use prewash and high temperatures for laundry that is not heavily soiled or stained.
- If you plan to dry your laundry in a dryer, select the highest spin speed recommended during washing process.
- Do not use more detergent than the recommended amount specified on its package.

## 4.5.4 Loading the laundry

1. Open the laundry cover.
2. Put the laundry items into the product in a loose manner.
3. Push and close the loading cover until you hear the locking sound. Ensure that no items are caught in the door. The loading door is locked while a programme is running. The door can only be opened a while after the programme comes to an end. Then you can open the loading cover.

## 4.5.5 Correct load capacity

The maximum load capacity depends on the type of laundry, the degree of soiling and the washing programme desired.

The product automatically adjusts the water amount according to the weight of the laundry put inside it.

**A**

**WARNING:** Comply with the information in the section "Programme and consumption table". When overloaded, product's washing performance will drop. Moreover, noise and vibration problems may occur.

## 4.5.6 Using detergent and softener

**C**

When using detergent, softener, starch, fabric dye, bleach and decolorant, descaling agents; read the manufacturer's instructions written on the package and follow the dosages specified. Use measuring cup if available.



The detergent drawer is composed of three compartments:

- (1) for prewash
- (2) for main wash
- (3) for softener
- (☹) in addition, there is a siphon piece in the softener compartment.

## Detergent, softener and other cleaning agents

- Add detergent and softener before starting the washing programme.
- While the washing cycle is in progress, do not leave the detergent dispenser open!
- When using a programme without prewash, do not put any detergent into the prewash compartment (compartment nr. "1").
- In a programme with prewash, do not put liquid detergent into the prewash compartment (compartment nr. "1").
- Do not select a programme with prewash if you are using a detergent bag or dispensing ball. Place the detergent bag or the dispensing ball directly among the laundry in the product.

- If you are using liquid detergent, do not forget to place the liquid detergent container into the main wash compartment (compartment number "2").

### Choosing the detergent type

Detergent type to be used depends on the fabric type and color.

- Use different detergents for coloured and white laundry.
- Wash your delicate clothes only with special detergents (liquid detergent, wool shampoo, etc.) used solely for delicate clothes.
- When washing dark coloured clothes and quilts, it is recommended to use liquid detergent.
- Wash woolens with special detergent made specifically for woolens.

**A**

**CAUTION:** Use only detergents manufactured specifically for washing machines.

**CAUTION:** Do not use soap powder.

### Adjusting detergent amount

The amount of washing detergent to be used depends on the amount of laundry, the degree of soiling and water hardness.

- Do not use amounts exceeding the dosage quantities recommended on the detergent package to avoid problems of excessive foam, poor rinsing, financial savings and finally, environmental protection.
- Use lesser detergent for small amounts or lightly soiled clothes.

### Using softeners

Pour the softener into the softener compartment of the detergent drawer.

- Do not exceed the (>max<) level sign on the softener compartment.
- If the softener has lost its fluidity, dilute it with water before putting it in the detergent compartment.

### Using liquid detergents

#### If the product contains a liquid detergent cup:

- Put the liquid detergent container into the compartment no "2".
- If the liquid detergent lost its fluidity, dilute it with water before putting it into the detergent container.



#### If the product does not contain a liquid detergent cup:

- Do not use liquid detergent for the prewash in a programme with prewash.
- Liquid detergent stains your clothes when used with "End Time" function to started delayed. If you are going to use the End Time function, do not use liquid detergent.

### Using gel and tablet detergent

- If the gel detergent thickness is fluidal and your product does not contain a special liquid detergent cup, put the gel detergent into the main wash detergent compartment during first water intake. If your product contains a liquid detergent cup, fill the detergent into this cup before starting the programme.
- If the gel detergent thickness is not fluidal or in the shape of capsule liquid tablet, put it directly into the drum before washing.
- Put tablet detergents into the main wash compartment (compartment nr. "2") or directly into the drum before washing.

### **Using starch**

- Put the liquid soda, powder soda or the fabric dye into the softener compartment. Do not use softener and starch together in a washing cycle.
- Wipe the inside of the product with a damp and clean cloth after using starch.

### **Using limescale remover**

- When required, use limescale removers manufactured specifically for washing machines only.

### **Using bleaches**

Add the bleach at the beginning of the washing cycle by selecting a prewash program.

Do not put detergent in the prewash compartment. As an alternative application, select a programme with extra rinse and add the bleaching agent while the product is taking water from the detergent compartment during first rinsing step.

- Do not use bleaching agent and detergent by mixing them.
- Use just a little amount (1/2 tea glass - approx. 50 ml) of bleaching agent and rinse the clothes very well as it causes skin irritation.
- Do not pour the bleach onto the laundry.
- Do not use it with the colored items.
- When using oxygen-based decolorant, select a program which washes the laundry at a low temperature.
- Oxygen-based decolorants can be used together with the detergent. However, if its thickness is not the same with the detergent, put the detergent first into the compartment nr. "2" in the detergent drawer and wait until the detergent flows while the product is taking in water. While the machine continues taking in water, add decolorant in the same compartment.

## 4.5.7 Tips for efficient washing

		Clothes			
		Light Colours and Whites	Colours	Black/Dark Colours	Delicates/Woolens/Silks
		(Recommended temperature range based on soiling level: 40-90 °C)	(Recommended temperature range based on soiling level: cold -40 °C)	(Recommended temperature range based on soiling level: cold -40 °C)	(Recommended temperature range based on soiling level: cold -30 °C)
<b>Soiling Level</b>	<b>Heavily Soiled</b> (difficult stains such as grass, coffee, fruits and blood.)	It may be necessary to pre-treat the stains or perform prewash. Powder and liquid detergents recommended for whites can be used at dosages recommended for heavily soiled clothes. It is recommended to use powder detergents to clean clay and soil stains and the stains that are sensitive to bleaches.	Powder and liquid detergents recommended for colors can be used at dosages recommended for heavily soiled clothes. It is recommended to use powder detergents to clean clay and soil stains and the stains that are sensitive to bleaches. Detergents which do not contain bleach should be used.	Liquid detergents suitable for colors and dark colors can be used at dosages recommended for heavily soiled clothes.	Prefer liquid detergents produced for delicate clothes. Woolen and silk clothes must be washed with special woolen detergents.
	<b>Normally Soiled</b> (For example, stains caused by body on collars and cuffs)	Powder and liquid detergents recommended for whites can be used at dosages recommended for normally soiled clothes.	Powder and liquid detergents recommended for colors can be used at dosages recommended for normally soiled clothes. Detergents which do not contain bleach should be used.	Liquid detergents suitable for colors and dark colors can be used at dosages recommended for normally soiled clothes.	Prefer liquid detergents produced for delicate clothes. Woolen and silk clothes must be washed with special woolen detergents.
	<b>Lightly Soiled</b> (No visible stains exist.)	Powder and liquid detergents recommended for whites can be used at dosages recommended for lightly soiled clothes.	Powder and liquid detergents recommended for colors can be used at dosages recommended for lightly soiled clothes. Detergents which do not contain bleach should be used.	Liquid detergents suitable for colors and dark colors can be used at dosages recommended for lightly soiled clothes.	Prefer liquid detergents produced for delicate clothes. Woolen and silk clothes must be washed with special woolen detergents.

## 4.6 Operating the product

### 4.6.1 Control panel

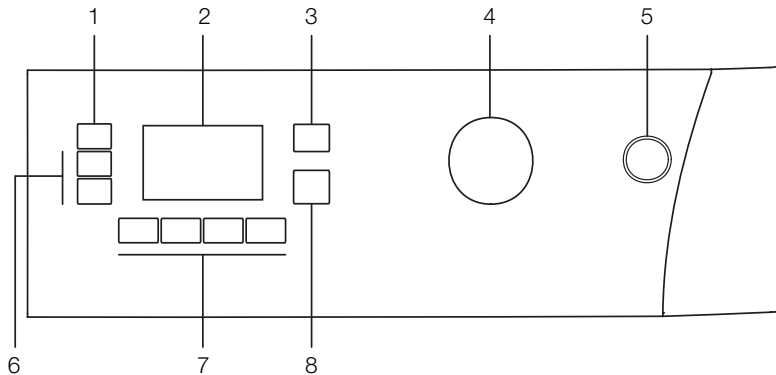

- 1 - Spin Speed Adjustment button
- 2 - Display
- 3 - Temperature Adjustment button
- 4 - Programme Selection knob

- 5 - On / Off button
- 6 - Delayed Start buttons (+ / -)
- 7 - Auxiliary Function buttons
- 8 - Start / Pause / Cancel button

### 4.6.2 Display symbols

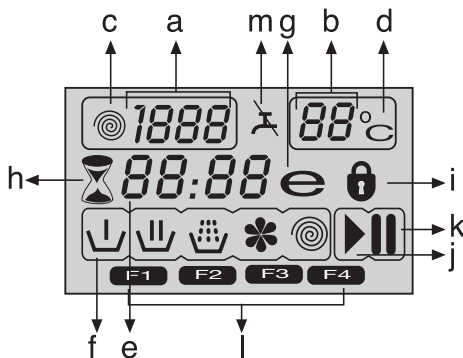

- a - Spin Speed indicator
- b - Temperature indicator
- c - Spin symbol
- d - Temperature symbol
- e - Remaining Time and Delayed Start indicator
- f - Programme Indicator symbols (Prewash / Main Wash / Rinse / Softener / Spin)
- g - Economy symbol
- h - Delayed Start symbol
- i - Door Locked symbol
- j - Start symbol
- k - Pause symbol
- l - Auxiliary Function symbols
- m - No Water symbol

### 4.6.3 Preparing the machine

1. Make sure that the hoses are connected tightly.
2. Plug in your machine.
3. Turn the tap on completely.
4. Place the laundry in the machine.
5. Add detergent and fabric softener.

### 4.6.4 Programme selection

1. Select the programme suitable for the type, quantity and soiling degree of the laundry in accordance with the "Programme and consumption table" and the temperature table below.
2. Select the desired programme with the Programme Selection button.

### 4.6.5 Programmes

#### • Cottons

Use this programme for your cotton laundry (such as bed sheets, duvet and pillowcase sets, towels, bathrobes, underwear, etc.). Your laundry will be washed with vigorous washing action for a longer washing cycle.

#### • Synthetics

Use this programme to wash your synthetic clothes (shirts, blouses, synthetic/cotton blends, etc.). It washes with a gentle action and has a shorter washing cycle compared to the Cottons programme.

For curtains and tulle, use the Synthetic 40°C programme with prewash and anti-creasing functions selected. As their meshed texture causes excessive foaming, wash the veils/tulle by putting little amount of detergent into the main wash compartment. Do not put detergent in the prewash compartment.

#### • Woollens

Use this programme to wash your woolen clothes. Select the appropriate temperature complying with the tags of your clothes. Use appropriate detergents for woollens.

#### • Cottons Eco

You may wash your normally soiled durable cotton and linen laundry in this programme with the highest energy and water saving compared to all other wash programmes suitable for cottons. Actual water temperature may differ from the declared cycle temperature. Programme duration may automatically be shortened during later stages of the programme if you wash less amount (e.g. ½ capacity or less) of laundry. In this case energy and water consumption will be further decreased giving you the opportunity for a more economical wash. This feature is available for certain models having remaining time display.

#### • Baby + Toddler Clothing

Use this programme to wash baby laundry, and the laundry that belongs to allergic persons. Longer heating time and an additional rinsing step provide a higher level of hygiene.

#### • Handwas (Hand wash)

Use this programme to wash your woolen/delicate clothes that bear "not machine-washable" tags and for which hand wash is recommended. It washes laundry with a very gentle washing action to not to damage clothes.

- **Daily Quick**

Use this programme to wash your lightly soiled cotton clothes in a short time.

- **Xpress Super Short**

Use this programme to wash your little amount of lightly soiled cotton clothes in a short time.

- **Dark Care**

Use this programme to wash your dark coloured laundry, or the coloured laundry that you do not want them get faded. Washing is performed with less mechanical movements at low temperature. It is recommended to use liquid detergent or wool shampoo for dark coloured laundry.

- **Mixed Fabrics**

Use this programme to wash your cotton and synthetic clothes together without sorting them.

- **Shirts**

Use this programme to wash the shirts made of cotton, synthetic and synthetic blended fabrics together.

- **Freshen up**

Use this programme to remove the odour on the laundry that are worn only for once and do not contain any stains or dirt.

- **Eco Clean 20**

Use this programme, which is much more sensitive to environment and natural resources, to wash your lightly soiled and unstained cotton laundry (max. 3.5 kg) in a short time and economically.



It is recommended to use liquid detergent or gel washing detergent.

- **Self Clean**

Use this programme regularly (once in every 1-2 months) to clean the drum and provide the required hygiene. Run the programme without any laundry in the machine. To obtain better results, put powder limescale remover for washing machines into the detergent compartment II. When the programme is over, leave the loading door ajar so that the inside of the machine gets dry.



This is not a washing programme. It is a maintenance programme.

Do not run the programme when there is something in the machine. If you try to do so, the machine detects that there is a load inside and aborts the programme

- **Rinse**

Use this programme when you want to rinse or starch separately.

- **Spin+Drain**

Use this programme to apply an additional spin cycle for your laundry or to drain the water in the machine.

Before selecting this programme, select the desired spin speed and press Start / Pause / Cancel button. The machine will spin the laundry with the set spin speed and drain the water coming out of them.

If you wish to drain only the water without spinning your laundry, select the Pump+Spin programme and then select the No Spin function with the help of Spin Speed Adjustment button. Press Start / Pause / Cancel button.



Use a lower spin speed for delicate laundries.

#### 4.6.6 Temperature selection

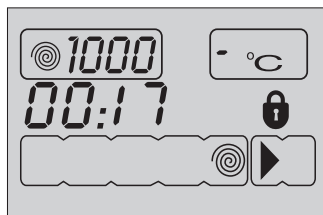

Whenever a new programme is selected, the maximum temperature for the selected programme appears on the temperature indicator.

To decrease the temperature, press the Temperature Adjustment button. Temperature decreases with increments of 10° and finally, "-" symbol indicating the cold wash option appears on the display.



If you scroll to cold wash option and press Temperature Adjustment button again, the recommended temperature for the selected programme appears on the display. Press the Temperature Adjustment button again to decrease the temperature.

#### 4.6.7 Economy symbol

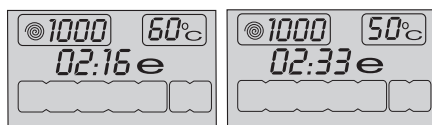

Indicates the programmes and temperatures that provide energy savings.



Economy symbol can not be selected in Intensive and Hygiene programmes since washing is performed in long times and at high temperatures in order to provide hygiene. Similarly, Economy symbol can not be selected in Baby, Refresh, Drum Cleaning, Spin and Rinse programmes as well.

#### 4.6.8 Spin speed selection

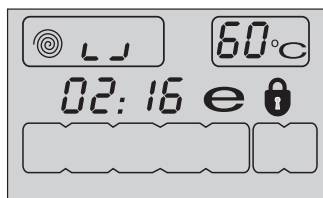

Whenever a new programme is selected, the recommended spin speed of the selected programme is displayed on the spin speed indicator.

To decrease the spin speed, press the Spin Speed Adjustment button. Spin speed decreases gradually. Then, depending on the model of the product, "Rinse Hold" and "No Spin" options appear on the display. See "Auxiliary function selection" section for explanations of these options.



Rinse Hold option is indicated with "LJ" symbol and No Spin option is indicated with "--" symbol.

## 4.6.9 Programme and consumption table

EN						Auxiliary functions						
Programme (°C)		Max. Load (kg)	Water Consumption (l)	Energy Consumption (kWh)	Max. Speed***	Prewash	Quicker Wash	Extra Rinse	Anti-Crease	Rinse Hold	Pet hair removal	Selectable temperature range °C
Cottons	90	7	66	2.10	1600	•	•	•	•	•	•	90-Cold
	60	7	64	1.55	1600	•	•	•	•	•	•	90-Cold
	40	7	64	0.90	1600	•	•	•	•	•	•	90-Cold
Baby & Toddler Clothing	90	7	70	2.00	1600			*		•		90-30
Cottons Eco	60**	7	48	1.00	1600					•		60-Cold
	60**	3.5	39	0.77	1600					•		60-Cold
	40**	3.5	39	0.75	1600					•		60-Cold
	40	7	60	0.84	1600					•		60-Cold
Synthetics	60	3	51	1.00	1200	•	•	•	•	•	•	60-Cold
	40	3	51	0.60	1200	•	•	•	•	•	•	60-Cold
Eco Clean 20	20	3.5	35	0.16	1600					•		20
Mixed Fabrics	40	3	45	0.50	1200	•	•	•	•	•	•	40-Cold
Shirts	40	3	45	0.50	800	•	•	•	*	•		60-Cold
Xpress Super Short	30	2	35	0.10	1400			•		•		30-Cold
Daily Quick	90	7	60	1.80	1400			•		•		90-Cold
	60	7	60	1.00	1400			•		•		90-Cold
	30	7	70	0.20	1400			•		•		90-Cold
Woollens	40	1.5	42	0.20	1200			•		•		40-Cold
Hand Wash	30	1	30	0.15	1200							30-Cold
Dark Care	40	3	65	0.55	1200			*		•		40-Cold
Self Clean	70	-	90	1.70	800			*				70

• : Selectable

\* : Automatically selected, no cancelling.

\*\* : Energy Label programme (EN 60456 Ed.3)

\*\*\* If maximum spin speed of the machine is lower then this value, you can only select up to the maximum spin speed.

- : See the programme description for maximum load.



\*\* "Cotton eco 40°C and Cotton eco 60°C are standard cycles." These cycles are known as '40°C cotton standard cycle' and '60°C cotton standard cycle' and indicated with the symbols on the panel.

	Load (kg)	Water Consumption (l)	Energy Consumption (kWh)	Programme Duration (min) *	Remaining Moisture Content (%) ** ≤ 1000 rpm	Remaining Moisture Content (%) ** > 1000 rpm
Synthetics 60	3	51	1.00	01:48	45	40
Synthetics 40	3	51	0.60	01:53	45	40

\* You can see the washing time of the programme you have selected on the display of the machine. It is normal that small differences may occur between the time shown on the display and the real washing time.

**C** The auxiliary functions in the table may vary according to the model of your machine. Water and power consumption may vary subject to the changes in water pressure, water hardness and temperature, ambient temperature, type and amount of laundry, selection of auxiliary functions and spin speed, and changes in electric voltage.

You can see the washing time of the programme you have selected on the display of the machine. It is normal that small differences may occur between the time shown on the display and the real washing time.

"Selectability of auxiliary functions might be changed by the manufacturer. New selectabilities might be added or existing ones might be removed."

"The spin speed of your machine may vary among the programmes, however this speed cannot exceed the max. spin speed of your machine."

#### 4.6.10 Auxiliary function selection

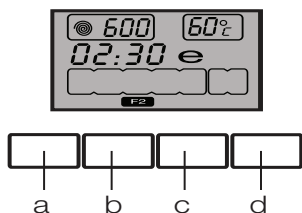

Select the desired auxiliary functions before starting the programme. Furthermore, you may also select or cancel auxiliary functions that are suitable to the running programme by pressing the Start / Pause / Cancel button when the machine is operating. For this, the machine must be in a step before the auxiliary function you are going to select or cancel.

Depending on the programme, press a, b, c or d buttons to select the desired auxiliary function. Symbol of the selected auxiliary function appears on the display.

**C** Some functions cannot be selected together. If a second auxiliary function conflicting with the first one is selected before starting the machine, the function selected first will be canceled and the second auxiliary function selection will remain active. For example, if you want to select Quick Wash after you have selected the Prewash, Prewash will be canceled and Quick Wash will remain active.

An auxiliary function that is not compatible with the programme cannot be selected. (See "Programme and consumption table")

Auxiliary Function buttons may vary according to the model of the machine.

### • Prewash

A Prewash is only worthwhile for heavily soiled laundry. Not using the Prewash will save energy, water, detergent and time.

F1 appears on the display when you select this function (a).

### • Quicker Wash

This function can be used in Cottons and Synthetics programmes. It decreases the washing times and also the number of rinsing steps for lightly soiled laundry.

F2 appears on the display when you select this function (b).

C

When you select this function, load your machine with half of the maximum laundry specified in the programme table.

### • Extra Rinse

This function enables the machine to make another rinsing in addition to the one already made after the main wash. Thus, the risk for sensitive skins (babies, allergic skins, etc.) to be effected by the minimal detergent remnants on the laundry can be reduced.

F3 appears on the display when you select this function (c).

### • Anti-Crease

This function creases the clothes lesser when they are being washed. Drum movement is reduced and spinning speed is limited to prevent creasing. In addition, washing is done with a higher water level.

F4 appears on the display when you select this function (d).

### • Rinse Hold

If you are not going to unload your clothes immediately after the programme completes, you may use rinse hold function to keep your laundry in the final rinsing water in order to prevent them from getting wrinkled when there is no water in the machine. Press Start / Pause / Cancel button after this process if you want to drain the water without spinning your laundry. Programme will resume and complete after draining the water.

If you want to spin the laundry held in water, adjust the Spin Speed and press Start / Pause / Cancel button.

The programme resumes. Water is drained, laundry is spun and the programme is completed.

### • Pet hair removal

This function helps to remove pet hair that remain on your garments more effectively.

When you select this function, Prewash and Extra Rinse steps are added to the normal programme. Thus, washing is performed with more water (30%) and the pet hair is removed more effectively.

A

**WARNING:** Never wash your pets in the washing machine.

## 4.6.11 Time display

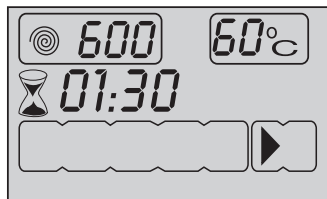

Remaining time to complete the programme appears on the display while the programme is running. Tim is displayed as "01:30" in hours and minutes format.



Programme time may differ from the values in the "Programme and consumption table" depending on the water pressure, water hardness and temperature, ambient temperature, amount and the type of laundry, auxiliary functions selected and the changes at the mains voltage.

## 4.6.12 Delayed start

With the Delayed Start function the startup of the programme may be delayed up to 24 hours. Delayed start time can be increased by increments of 30 minutes.



Do not use liquid detergents when you set Delayed Start! There is the risk of staining of the clothes.

1. Open the loading door, place the laundry and put detergent, etc.
2. Select the washing programme, temperature, spin speed and, if required, the auxiliary functions.
3. Set the desired delayed start time by pressing the Delayed Start + or - buttons. Delayed Start symbol flashes.
4. Press Start / Pause / Cancel button. Delayed start countdown starts. Delayed Start symbol illuminates steadily. Start symbol appears. ":" sign in the middle of the delayed start time on the display starts flashing.



Additional laundry may be loaded during the delayed start period. At the end of the countdown, Delayed Start symbol disappears, washing cycle starts and the time of the selected programme appears on the display.

### Changing the delayed start period

If you want to change the time during countdown:

1. Press Start / Pause / Cancel button. ":" sign in the middle of the delayed start time on the display stops flashing. Pause symbol appears. Delayed Start symbol flashes. Start symbol disappears.
2. Set the desired delayed start time by pressing the Delayed Start + or - buttons.
3. Press Start / Pause / Cancel button. Delayed Start symbol illuminates steadily. Pause symbol disappears. Start symbol appears.
4. ":" sign in the middle of the delayed start time on the display starts flashing.

### Cancelling the Delayed Start function

If you want to cancel the delayed start countdown and start the programme immediately:

1. Press Start / Pause / Cancel button. ":" sign in the middle of the delayed start time on the display stops flashing.
2. Start symbol disappears. Pause symbol and Delayed Start symbol flashes.
3. Decrease the delayed start time by pressing the Delayed Start - button. Programme duration appears after 30 minutes.
4. Press Start / Pause / Cancel button to start the programme.

## 4.6.13 Starting the programme

1. Press Start / Pause / Cancel button to start the programme.
2. Start symbol showing the startup of the programme will turn on.
3. Loading door is locked and Door Locked symbol appears on the display.
4. The symbol of the step from which the programme has started appears on the display (Prewash, Main Wash, Rinse, Softener and Spin).

## 4.6.14 Progress of programme

Progress of a running programme is indicated on the display with a set of symbols. Relevant symbol appears on the display at the beginning of each programme step and all symbols remain lit at the end of the programme. The farthestmost right symbol indicates the current programme step.

### **Prewash**

If the Prewash auxiliary function is selected, Prewash symbol appears on the display indicating that the prewash step has started.

### **Main Wash**

Main Wash symbol indicating that the main wash step has started appears on the display.

### **Rinse**

Rinse symbol indicating that the rinsing step has started appears on the display.

### **Softener**

Softener symbol indicating that the softener step has started appears on the display.

### **Spin**

Appears at the beginning of the final spin step and remains lit during Spin and Pump special programmes.



If the machine does not pass to the spinning step, Rinse Hold function might be active or the automatic unbalanced load detection system might be activated due to the unbalanced distribution of the laundry in the machine.

## 4.6.15 Loading door lock

There is a locking system on the loading door of the machine that prevents opening of the door in cases when the water level is unsuitable.

Door Locked symbol appears when the loading door is locked. This symbol will flash until the loading door becomes ready to open when programme completes or the machine is paused. Do not force to open the loading door in this step. Symbol disappears when the door is ready to open. You can open the door when the symbol disappears.

## 4.6.16 Changing the selections after programme has started

### Switching the machine to pause mode

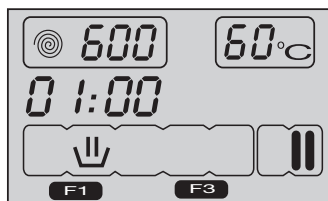

Press the Start / Pause / Cancel button to switch the machine to pause mode. Pause symbol appears on the display indicating that the machine is paused. Start symbol disappears.

### Changing the speed and temperature settings for auxiliary functions

Depending on the step the programme has reached, you may cancel or activate the auxiliary functions; see, "Auxiliary function selection".

You may also change the speed and temperature settings; see, "Spin speed selection" and "Temperature selection".

### Adding or taking out laundry

1. Press the Start / Pause / Cancel button to switch the machine to pause mode. The programme follow-up light of the relevant step during which the machine was switched into the pause mode will flash.
2. Wait until the Loading Door can be opened.
3. Open the Loading Door and add or take out the laundry.
4. Close the Loading Door.
5. Make changes in auxiliary functions, temperature and speed settings if necessary.
6. Press Start / Pause / Cancel button to start the machine.



The loading door will not open if the water temperature in the machine is high or the water level is above the door opening.

## 4.6.17 Child Lock

Use Child Lock function to prevent children from tampering with the machine. Thus you can avoid any changes in a running programme.



You can switch on and off the machine with On / Off button when the Child Lock is active. When you switch on the machine again, programme will resume from where it has stopped.

### To activate the Child Lock:

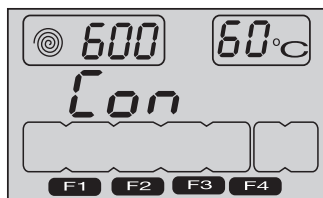

Press and hold 2nd and 4th Auxiliary Function buttons for 3 seconds. "Con" appears on the display.



Same phrase will appear on the display if you press any button when Child Lock is enabled.

## To deactivate the Child Lock:

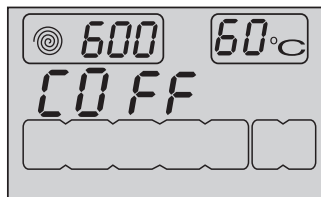

Press and hold 2nd and 4th Auxiliary Function buttons for 3 seconds. "COFF" appears on the display.



Do not forget to disable the child lock at the end of the programme if it was enabled before. Otherwise, machine will not allow to select a new programme.

## 4.6.18 Cancelling the programme

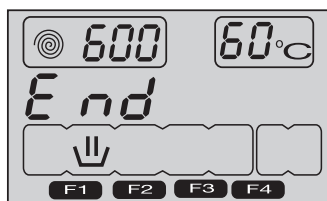

Press and hold Start / Pause / Cancel button for 3 seconds. Start symbol flashes. Symbol of the step at which the programme was cancelled remains lit. „End“ appears on the display and the programme is cancelled.



If you want to open the loading door after you have cancelled the programme but it is not possible to open the loading door since the water level in the machine is above the loading door opening, then turn the Programme Selection knob to Pump+Spin programme and discharge the water in the machine.

## 4.6.19 Machine is in Rinse Hold mode

Spin symbol flashes and Pause symbol illuminates when the machine is in Rinse Hold mode.

If you want to spin your laundry when the machine is in this mode:

Adjust the spin speed and press Start / Pause / Cancel button. Pause symbol disappears and Start symbol appears. Programme resumes, discharges the water and spins the laundry.

If you only want to drain the water without spinning:

Just press Start / Pause / Cancel button. Pause symbol disappears. Start symbol appears. Programme resumes and discharges the water only.

## 4.6.20 End of programme

"End" appears on the display at the end of the programme. Symbols of the programme steps remain lit. Auxiliary function, spin speed and temperature that were selected at the beginning of the programme remain selected.

## 4.6.21 Your machine is equipped with a "Standby Mode"

In case of not starting any programme or waiting without making any other operation when the machine is turned on by On/Off button and while it is in selection step or if no other operation is performed approximately 2 minutes after the programme you selected has come to an end, your machine will automatically switch to energy saving mode. Brightness of indicator lights will decrease. Also, if your product is equipped with a display

## 4.7 Maintenance and cleaning

Service life of product extends and frequently experienced problems will be reduced if it is cleaned at regular intervals.

### 4.7.1 Cleaning the detergent drawer

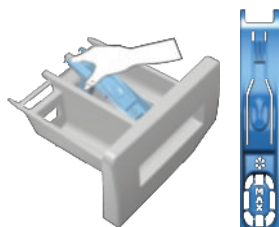

Clean the detergent drawer at regular intervals (every 4-5 washing cycles) as shown below in order to prevent accumulation of powder detergent in time. If more than normal amount of water and softener mixture starts to gather in the softener compartment, the siphon must be cleaned.

- 1 Press the dotted point on the siphon in the softener compartment and pull towards you until the compartment is removed from the machine.
- 2 Lift the rear part of the siphon to remove it as illustrated.
- 3 Wash the detergent drawer and the siphon with plenty of lukewarm water in a washbasin. In order to prevent the residues to contact your skin, clean it with an appropriate brush by wearing a pair of gloves.
- 3 Insert the drawer back into its place after cleaning and make sure that it is seated well.

### 4.7.2 Cleaning the loading door and the drum

For products with drum cleaning programme, please see Operating the product - Programmes.

For products without drum cleaning, follow the below steps **to clean the drum**:

Select **Additional Water** or **Extra Rinse** auxiliary functions. Use a Cottons **programme** without pre-wash. Set **the temperature to the level recommended on the drum cleaning agent which can be provided from authorized services**. Apply this procedure **without any laundry in the product**. Before starting the programme, put 1 pouch of special drum cleaning agent (if the special agent could not be supplied, put max. 100 g of powder anti-limescale) into the main wash detergent compartment (compartment no. „2“). If the anti-limescale is in tablet form, put only one tablet into the main wash compartment no. „2“. Dry the inside of the bellow with a clean piece of cloth after the programme has come to an end.



Repeat Drum Cleaning process in every 2 months.

Use an anti-limescale suitable for the washing machines.

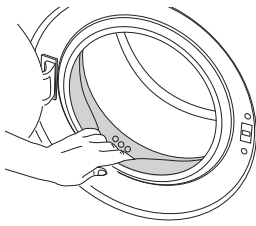

After every washing make sure that no foreign substance is left in the drum.

If the holes on the bellow shown in the figure is blocked, open the holes using a toothpick.

Foreign metal substances will cause rust stains in the drum. Clean the stains on the drum surface by using cleaning agents for stainless steel.

Never use steel wool or wire wool. These will damage the painted, chromated and plastic surfaces.

#### 4.7.3 Cleaning the body and control panel

Wipe the body of the product with soapy water or non-corrosive mild gel detergents as necessary, and dry with a soft cloth.

Use only a soft and damp cloth to clean the control panel.

#### 4.7.4 Cleaning the water intake filters

There is a filter at the end of each water intake valve at the rear of the product and also at the end of each water intake hose where they are connected to the tap. These filters prevent foreign substances and dirt in the water to enter the product. Filters should be cleaned as they do get dirty.

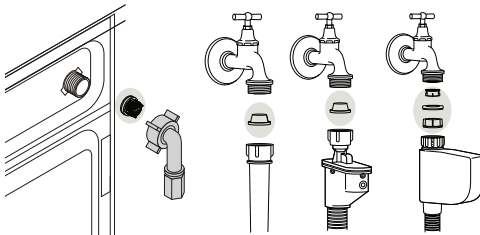

1. Close the taps.
2. Remove the nuts of the water intake hoses to access the filters on the water intake valves. Clean them with an appropriate brush. If the filters are too dirty, remove them from their places with a pliers and clean in this way.
3. Take out the filters on the flat ends of the water intake hoses together with the gaskets and clean thoroughly under running water.
4. Replace the seals and filters carefully and tighten their nuts by hand.

## 4.7.5 Draining remaining water and cleaning the pump filter

The filter system in your product prevents solid items such as buttons, coins and fabric fibers clogging the pump impeller during discharge of washing water. Thus, the water will be discharged without any problem and the service life of the pump will extend. If the product fails to drain water inside it, the pump filter is clogged. Filter must be cleaned whenever it is clogged or in every 3 months. Water must be drained off first to clean the pump filter. In addition, prior to transporting the product (e.g., when moving to another house) water should be drained completely.

**A**

**CAUTION:** Foreign substances left in the pump filter may damage your product or may cause noise problem.

**CAUTION:** In regions where freezing is possible, the faucet must be closed, system hose must be removed and the water inside the product must be drained when the product is not in use.

**CAUTION:** After each use, turn off the water tap to which the mains hose is connected.

### In order to clean the dirty filter and discharge the water:

1. Unplug the product to cut off the supply power.

**A**

**CAUTION:** Temperature of the water inside the product may rise up to 90 °C. To avoid the burning risk, clean the filter after the water inside the product is cooled down.

2. Open the filter cover.

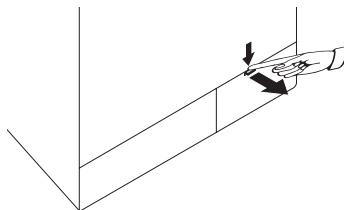

If the filter cap is composed of two pieces, press the tab on the filter cap downwards and pull the piece out towards yourself.

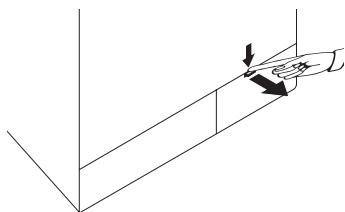

If the filter cap is one piece, pull the cap from both sides at the top to open. You can remove the filter cover by slightly pushing downwards with a thin plastic tipped tool, through the gap above the filter cover. Do not use metal tipped tools to remove the cover.

3 Follow the below procedures in order to drain water.

**If the product has an emergency water draining hose, in order to drain the water:**

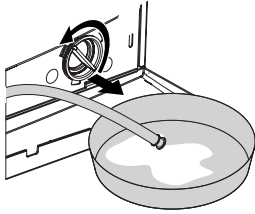

- a Pull the emergency draining hose out from its seat
- b Place a large container at the end of the hose. Drain the water into the container by pulling out the plug at the end of the hose. When the container is full, block the inlet of the hose by replacing the plug. After the container is emptied, repeat the above procedure to drain the water in the product completely.
- c When draining of water is finished, close the end by the plug again and fix the hose in its place.
- d Turn and remove the pump filter.

**If the product does not have an emergency water drain hose, in order to drain the water:**

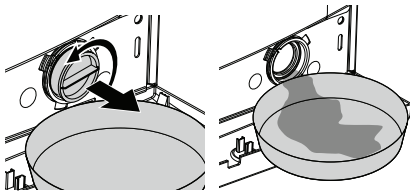

- a. In order to collect the water to flow out of the filter, place a large vessel in front of the filter.
  - b. Turn and loosen the pump filter until water starts to flow (counterclockwise). Fill the flowing water into the container you have placed in front of the filter. Always keep a piece of cloth handy to absorb any spilled water.
  - c. When the water inside the product is finished, take out the filter completely by turning it.
- 4 Clean any residues inside the filter as well as fibers, if any, around the pump impeller region.
  5. Replace the filter.
  6. If the filter cap is composed of two pieces, close the filter cap by pressing on the tab. If it is one piece, seat the tabs in the lower part into their places first, and then press the upper part to close.

## 5 Troubleshooting

Problem	Reason	Solution
Programme cannot be started or selected.	The product may have switched to self protection mode due to a supply problem (line voltage, water pressure, etc.).	♦ Press and hold Start / Pause / Cancel button for 3 seconds to reset the product to factory settings. (See. Cancelling the programme")
Water inside the product.	Some water might have remained in the product due to the quality control processes in the production.	♦ This is not a failure; water is not harmful to the product.
The product does not take water in.	Tap is turned off.	♦ Turn on the taps.
	Water inlet hose is bent.	♦ Flatten the hose.
	Water inlet filter is clogged.	♦ Clean the filter.
	Loading door may be open.	♦ Close the door.
The product does not drain water.	Water drain hose might be clogged or twisted.	♦ Clean or flatten the hose.
	Pump filter is clogged.	♦ Clean the pump filter.
Product vibrates or makes noise.	Product might be standing unbalanced.	♦ Stable the product by adjusting the feet.
	A hard substance might have entered into the pump filter.	♦ Clean the pump filter.
	Transportation safety bolts are not removed.	♦ Remove the transportation safety bolts.
	Laundry quantity in the product might be too little.	♦ Add more laundry to the product.
	Excessive laundry might be loaded in the product.	♦ Take out some of the laundry from the product or distribute the load by hand to balance it homogenously in the product.
	Product might be leaning on a rigid item.	♦ Make sure that the product is not leaning on anything.
There is water leaking from the bottom of the product.	Water drain hose might be clogged or twisted.	♦ Clean or flatten the hose.
	Pump filter is clogged.	♦ Clean the pump filter.
Product stopped shortly after the programme started.	Machine might have stopped temporarily due to low voltage.	♦ Product will resume running when the voltage restores to the normal level.
Product directly discharges the water it takes in.	Draining hose might not be at adequate height.	♦ Connect the water draining hose as described in the operation manual.
No water can be seen in the product during washing.	Water is inside the invisible part of the product.	♦ This is not a failure.
Loading door cannot be opened.	The cover lock is activated due to the water level inside the product.	♦ Drain the water by running the Pump or Spin programme.
	Product is heating up the water or it is at the spinning cycle.	♦ Wait until the programme completes.
	Child lock is engaged. Door lock will be deactivated a couple of minutes after the programme has come to an end.	♦ Wait for a couple of minutes for deactivation of the door lock.

<b>Problem</b>	<b>Reason</b>	<b>Solution</b>
Washing takes longer time than specified in the manual.(*)	Water pressure is low.	♦ Product waits until taking in adequate amount of water to prevent poor washing quality due to the decreased amount of water. Therefore, the washing time extends.
	Voltage might be low.	♦ Washing time is prolonged to avoid poor washing results when the supply voltage is low.
	Input temperature of water might be low.	♦ Required time to heat up the water extends in cold seasons. Also, washing time can be lengthened to avoid poor washing results.
	Number of rinses and/or amount of rinse water might have increased.	♦ Product increases the amount of rinse water when good rinsing is needed and adds an extra rinsing step if necessary.
	Excessive foam might have occurred and automatic foam absorption system might have been activated due to too much detergent usage.	♦ Use recommended amount of detergent.
Programme time does not countdown. (On models with display) (*)	Timer may stop during water intake.	♦ Timer indicator will not countdown until the product takes in adequate amount of water. The product will wait until there is sufficient amount of water to avoid poor washing results due to lack of water. Timer indicator will resume countdown after this.
	Timer may stop during heating step.	♦ Timer indicator will not countdown until the product reaches the selected temperature.
	Timer may stop during spinning step.	♦ Automatic unbalanced load detection system might be activated due to the unbalanced distribution of the laundry in the product.
Programme time does not countdown. (*)	There might be unbalanced load in the product.	♦ Automatic unbalanced load detection system might be activated due to the unbalanced distribution of the laundry in the product.
Product does not switch to spinning step. (*)	There might be unbalanced load in the product.	♦ Automatic unbalanced load detection system might be activated due to the unbalanced distribution of the laundry in the product.
	The product will not spin if water is not drained completely.	♦ Check the filter and the draining hose.
	Excessive foam might have occurred and automatic foam absorption system might have been activated due to too much detergent usage.	♦ Use recommended amount of detergent.

<b>Problem</b>	<b>Reason</b>	<b>Solution</b>
Washing performance is poor: Laundry turns gray. (**)	Insufficient amount of detergent has been used over a long period of time.	♦ Use the recommended amount of detergent appropriate for water hardness and the laundry.
	Washing was made at low temperatures for a long time.	♦ Select the proper temperature for the laundry to be washed.
	Insufficient amount of detergent is used with hard water.	♦ Using insufficient amount of detergent with hard water causes the soil to stick on the cloth and this turns the cloth into gray in time. It is difficult to eliminate graying once it happens. Use the recommended amount of detergent appropriate for water hardness and the laundry.
	Excessive amount of detergent was used.	♦ Use the recommended amount of detergent appropriate for water hardness and the laundry.
Washing performance is poor: Stains persist or the laundry is not whitened. (**)	Insufficient amount of detergent is used.	♦ Use the recommended amount of detergent appropriate for water hardness and the laundry.
	Excessive laundry was loaded in.	♦ Do not load the product in excess. Load with amounts recommended in the "4.6.2 Programme and consumption table".
	Wrong programme and temperature were selected.	♦ Select the proper programme and temperature for the laundry to be washed.
	Wrong type of detergent is used.	♦ Use original detergent appropriate for the product.
	Excessive amount of detergent was used.	♦ Put the detergent in the correct compartment. Do not mix the bleaching agent and the detergent with each other.
Washing performance is poor: Oily stains appeared on the laundry. (**)	Regular drum cleaning is not applied.	♦ Clean the drum regularly. For this procedure, please see "4.7.2 Cleaning the loading door and the drum".
Washing performance is poor: Clothes smell unpleasantly. (**)	Odours and bacteria layers are formed on the drum as a result of continuous washing at lower temperatures and/or in short programmes.	♦ Leave the detergent drawer as well as the loading door of the product ajar after each washing. Thus, a humid environment favorable for bacteria cannot occur in the machine.
Colour of the clothes faded. (**)	Excessive laundry was loaded in.	♦ Do not load the product in excess.
	Detergent in use is damp.	♦ Keep detergents closed in an environment free of humidity and do not expose them to excessive temperatures.
	A higher temperature is selected.	♦ Select the proper programme and temperature according to the type and soiling degree of the laundry.

<b>Problem</b>	<b>Reason</b>	<b>Solution</b>
It does not rinse well.	The amount, brand and storage conditions of the detergent used are inappropriate.	♦ Use a detergent appropriate for the washing machine and your laundry. Keep detergents closed in an environment free of humidity and do not expose them to excessive temperatures.
	Detergent is put in the wrong compartment.	♦ If detergent is put in the prewash compartment although prewash cycle is not selected, the product can take this detergent during rinsing or softener step. Put the detergent in the correct compartment.
	Pump filter is clogged.	♦ Check the filter.
	Drain hose is folded.	♦ Check the drain hose.
Laundry became stiff after washing. (**)	Insufficient amount of detergent is used.	♦ Using insufficient amount of detergent for the water hardness can cause the laundry to become stiff in time. Use appropriate amount of detergent according to the water hardness.
	Detergent is put in the wrong compartment.	♦ If detergent is put in the prewash compartment although prewash cycle is not selected, the product can take this detergent during rinsing or softener step. Put the detergent in the correct compartment.
	Detergent might be mixed with the softener.	♦ Do not mix the softener with detergent. Wash and clean the dispenser with hot water.
Laundry does not smell like the softener. (**)	Detergent is put in the wrong compartment.	♦ If detergent is put in the prewash compartment although prewash cycle is not selected, the product can take this detergent during rinsing or softener step. Wash and clean the dispenser with hot water. Put the detergent in the correct compartment.
	Detergent might be mixed with the softener.	♦ Do not mix the softener with detergent. Wash and clean the dispenser with hot water.

Problem	Reason	Solution
Detergent residue in the detergent drawer. (**)	Detergent is put in wet drawer.	♦ Dry the detergent drawer before putting in detergent.
	Detergent has gotten damp.	♦ Keep detergents closed in an environment free of humidity and do not expose them to excessive temperatures.
	Water pressure is low.	♦ Check the water pressure.
	The detergent in the main wash compartment got wet while taking in the prewash water. Holes of the detergent compartment are blocked.	♦ Check the holes and clean if they are clogged.
	There is a problem with the detergent drawer valves.	♦ Call the Authorized Service Agent.
	Detergent might be mixed with the softener.	♦ Do not mix the softener with detergent. Wash and clean the dispenser with hot water.
	Regular drum cleaning is not applied.	♦ Clean the drum regularly. For this procedure, please see "4.7.2 Cleaning the loading door and the drum".
Too much foam forms inside the product. (**)	Improper detergents for the washing machine are being used.	♦ Use detergents appropriate for the washing machine.
	Excessive amount of detergent is used.	♦ Use only sufficient amount of detergent.
	Detergent was stored under improper conditions.	♦ Store detergent in a closed and dry location. Do not store in excessively hot places.
	Some meshed laundry such as tulle may foam too much because of their texture.	♦ Use smaller amounts of detergent for this type of item.
	Detergent is put in the wrong compartment.	♦ Put the detergent in the correct compartment.
	Softener is being taken early by the product.	♦ There may be problem in the valves or in the detergent dispenser. Call the Authorized Service Agent.
Foam is overflowing from the detergent drawer.	Too much detergent is used.	♦ Mix 1 tablespoonful softener and ½ l water and pour into the main wash compartment of the detergent drawer.
		♦ Put detergent into the product suitable for the programmes and maximum loads indicated in the "4.6.2 Programme and consumption table". When you use additional chemicals (stain removers, bleaches and etc), reduce the amount of detergent.
Laundry remains wet at the end of the programme. (*)	Excessive foam might have occurred and automatic foam absorption system might have been activated due to too much detergent usage.	♦ Use recommended amount of detergent.

(\*) The product does not switch to spinning step when the laundry is not evenly distributed in the drum to prevent any damage to the product and to its surrounding environment. Laundry should be rearranged and re-spun.

(\*\*) Regular drum cleaning is not applied. Clean the drum regularly. See 4.7.2

# A

**CAUTION:** If you cannot eliminate the problem although you follow the instructions in this section, consult your dealer or the Authorized Service Agent. Never try to repair a nonfunctional product yourself.







# Service

---

Please keep your purchase receipt or other proof of purchase in a safe place; you will need to have it should the product require attention under guarantee.

You should also complete the details below; it will help us assist you when requesting service. (The model number is printed on the Instruction Booklet and the serial number is printed on the Rating Label affixed to the appliance)

Model No:

Serial No:

Retailer:

Date of purchase:

For service under guarantee simply telephone the appropriate number below

## **UK Mainland & Northern Ireland**

Fridges & Freezers 0845 600 4903

Electric Cookers 0845 600 4902

Gas & 0845 600 4905

Dual Fuel Cookers

Washing Machines & 0845 600 4906

Dishwashers

## **Republic of Ireland**

All Refrigeration, 01 862 3411

All Cookers

Washing Machines & Dishwashers

Before requesting service please check the trouble-shooting guide in the Operating Instructions as a charge may be levied where no fault is found even though your product may still be under guarantee.

## **Service once the manufacturers guarantee has expired.**

If you have purchased an extended guarantee please refer to the instructions contained within the extended guarantee agreement document. Otherwise please call the appropriate number above where service can be obtained at a charge.

Should you experience any difficulty in obtaining service please contact the Beko Customer Help-Line.

Tel: 0845 600 4911

e-mail:service@beko.co.uk

---

# Guarantee

## Washing Machine

Your new Beko product is guaranteed against the cost of breakdown repairs for twelve months from the date of the original purchase.

### **What is covered?**

- Repairs necessary as a result of faulty materials, defective components or manufacturing defect.
- The cost of functional replacement parts, but excluding consumable items.
- The labour costs of a Beko approved repairer to carry out the repair.

### **What is not covered?**

- Transit, delivery or accidental damage or misuse and abuse.
- Cabinet or appearance parts, including knobs, flaps, handles or container lids.
- Accessories or consumable items including but not limited to, ice trays, scrapers, cutlery baskets, filters and light bulbs.
- Repairs required as a result of unauthorised repair or inexperienced installation that fails to meet the requirements contained in the user instruction book.
- Repairs to products used on commercial or non-residential household premises.
- Loss of frozen food in freezers or fridge/freezers. (Food loss insurance is often included within your household contents insurance policy, or may be available separately from your retailer).

### **Important notes.**

- Your Beko product is designed and built for domestic household use only.
- The guarantee will be void if the product is installed or used in commercial or non-residential domestic household premises.
- The product must be correctly installed, located and operated in accordance with the instructions contained in the User Instructions Booklet provided.
- Professional installation by a qualified Electrical Domestic Appliance Installer is recommended for all Washing Machines, Dishwashers and Electric Cookers
- Gas Cookers must only be installed by a CORGI (or BORD GAIS) registered Gas Installer.
- The guarantee is given only within the boundaries of the United Kingdom and the Republic of Ireland.
- The guarantee is applicable only to new products and is not transferable if the product is resold.
- Beko disclaims any liability for incidental or consequential damages.
- The guarantee does not in anyway diminish your statutory or legal rights.

Should you experience any difficulty in obtaining service please contact the Beko Customer Help-Line.

Tel: 0845 600 4911

e-mail:service@beko.co.uk