

洗衣机 Washing Machine

WMT 8320
WMT 8320 S

用户手册
User's Manual

Blomberg

请首先阅读本用户手册！

亲爱的顾客，

我们的产品使用先进设备生产，并通过严格的质量控制检测，希望您能从中获取最大的效益。

因此，使用本产品前，请仔细阅读完整的用户手册，并妥善保管，以备日后使用。如果将本产品转让他人，请一并移交该手册。

该用户手册将帮助您快速、安全地使用本设备。

- 安装和启动本产品前，请阅读用户手册。
- 始终遵循安全须知。
- 妥善保管该用户手册，以备日后参考。
- 也请阅读本产品随附的其它文件。

请注意，该用户手册也适用于其它多种型号。手册中将标出不同型号之间的差异。

符号解释

本用户手册中，使用了下列符号：

- C 有关应用的重要信息或有用的提示。
- A 有关生命和财产之危险情况的警告。
- B 触电警告。



該電器的包裝材料是可迴圈使用的。請出於環保的目的，配合迴圈利用，將相應的包裝材料交到當地政府設立的回收站。本機器中確實含有大量可回收的成分，並且有相應的指示標籤。儘量不要將這些可回收的包裝材料與其他垃圾混合。本機器的回收標準符合歐盟的電器及電子垃圾回收指令2002/96/EC。請聯繫當地政府或者經銷商，以找到就近的回收站。我們誠摯地感謝您為環保而作出的努力！

目录

1您的洗衣机	4	开始程序..... 20
概况..... 4		程序进程..... 20
技术规格..... 5		程序启动后的修改..... 20
2重要安全须知	6	儿童安全锁..... 20
一般安全..... 6		通过取消结束程序..... 21
指定使用..... 6		
儿童的安全..... 6		
3安装	7	6维护与清洁
适当的安装位置..... 7		22
拆除包装紧固件..... 7		清洁洗涤剂抽屉..... 22
打开运输锁..... 7		清洁装填门和滚筒..... 22
连接水源..... 8		清洁机体和控制面板..... 22
连接排水管..... 8		清洁进水过滤器..... 22
调整机脚..... 9		排空所有残留的水，并清洁水泵过滤器 23
电气连接..... 9		
首次使用.....		
处置包装材料.....		
产品运输.....		
废旧设备的处置.....		
4准备	10	7故障检修
节能措施..... 10		25
给衣物分类..... 10		
准备需要洗涤的衣物..... 10		
正确的装载容量..... 11		
装入衣物..... 11		
使用洗涤剂和柔顺剂..... 12		
使用液体洗涤剂..... 12		
5 选择洗涤程序	14	
控制面板..... 14		
开启机器..... 15		
程序选择..... 15		
脱水转速选择..... 15		
主洗涤程序..... 15		
附加程序..... 16		
甩干速度选择..... 16		
程序选择及耗水耗电量表..... 18		
附加功能..... 19		
时间显示..... 19		

1 您的洗衣机

概况

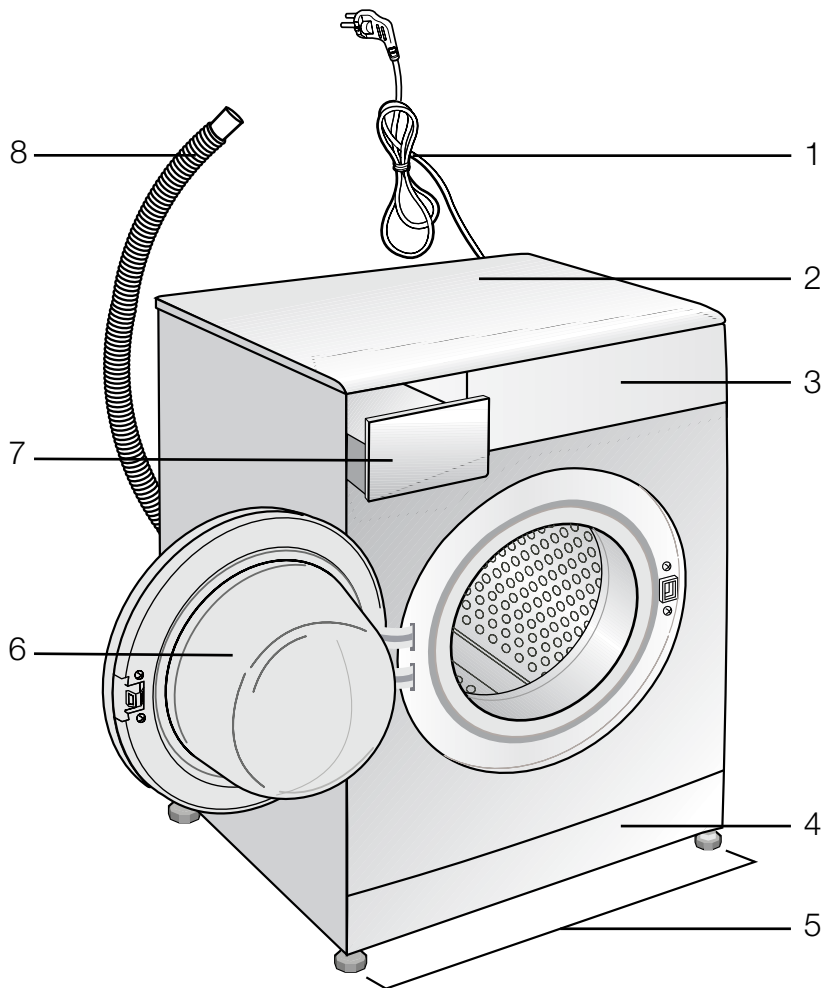

1- 电源线

2- 顶部面板

3- 控制面板

4- 过滤器盖

5- 可调支腿

6- 装填门

7- 洗涤剂分送屉

8- 排水软管

技术规格

型号	WMT 8320	WMT 8320 S
干衣物最大容量 (kg)	8	8
高度 (cm)	84	84
宽度 (cm)	60	60
深度 (cm)	59	59
净重 (±4 kg)	73	73
电力输入 (V/Hz)	220 V / 60Hz	220 V / 60Hz
总电流 (A)	9,5	9,5
总功率 (W)	1850	1850
甩干速度 (最大 rpm)	1200	1200

- ❗ 为提高产品质量，技术规格可能有所变化，恕不另行通知。
- C 本手册中的图片都是示意图，可能与您的产品有所不同。
- C 洗衣机标签或随机文件中给出的数值都是在实验室中按照相关标准获得的。根据产品运行条件 and 环境状况的不同，这些数值可能会有所不同。

本节包含安全须知，将帮助您免受个人伤害或财产损失。若违反这些安全须知，将导致保修条款失效。

一般安全

- 本产品并非设计供体力、感知力或精神障碍或经验和知识缺乏的人士（包括孩子）使用，除非有负责他们安全的人员给出有关本产品之使用的监督或指导。
- 切勿将本产品放在覆盖有地毯的地面上；否则，机器底部缺乏气流将导致电气零件过热。这可能导致本产品发生故障。
- 如果电源线/插头受损，请勿操作本产品。致电经授权的服务代理。
- 安排一位有资质的电工将 16 安培的保险丝连接到本产品的安装位置。
- 如果本产品有故障，在经授权的服务代理维修后，方可操作。否则，会有触电的危险！
- 在断电后电力恢复时，本产品可恢复工作。如果您希望取消程序，请参见“取消程序”部分。
- 将本产品连接到接地插座上，插座应当由符合“技术规范”表中数值的保险丝保护。请记得由有资历的电工实施接地安装。如果本产品没有根据当地规定，在没有接地的情况下使用，导致的任何损坏，我公司不承担任何责任。
- 给水和排水软管必须牢牢固定，且保持完好无损。否则，有漏水的危险。
- 滚筒里还有水时，切勿打开装填门或者拆卸过滤器。否则，有溢流的危险，且可能被热水烫伤。
- 请勿用力打开锁定的装填门。在洗涤循环结束后的几分钟，便可以准备打开装填门。如果强制打开装填

门，门和锁装置可能损坏。

- 不使用时，请拔下产品接头。
- 清洁时，切勿在该产品上洒水或倒水！否则，会有触电的危险！
- 切勿用潮湿的双手接触插头！拔下插头时，切勿拉拔电缆，而应直接握住插头。
- 只能使用适合洗衣机的洗涤剂、柔顺剂和补充剂。
- 请遵循织物标签和清洁剂包装上的说明。
- 安装、维护、清洁和修理过程中，必须拔下插头。
- 务必由经授权的服务代理，实施安装和修理步骤。对于由未经授权的人员实施的步骤导致的损坏，制造商不承担任何责任。

指定使用

- 本产品设计供家庭使用。其不适合商业用途，且不得用于除既定用途以外的场合。
- 本产品只可用于清洗和漂洗具有相应标记的衣物。
- 对于使用或运输错误导致的损害，制造商不承担任何责任。
- 本产品的使用寿命为 10 年。在此期间，将提供原装备件，以确保机器适当工作。

儿童的安全

- 电气产品会给儿童带来危险。本产品运行时，儿童不可靠近。请不要让儿童摆弄本产品。使用儿童锁，防止儿童干扰该产品运行。
- 离开本产品所在房间时，请记得关闭装填门。
- 妥善保管所有洗涤剂和添加剂，应置于儿童不可及之处。

3 安装

有关产品的安装，请就近与授权的服务代理联系。产品准备使用时，应查看用户手册中的信息，并确保电力、自来水和排水系统合适，之后，再致电授权服务代理。否则，请致电一位有资格的技师和水管工人，实施必要的安排。

- C 安装地点的电力、自来水和废水装置由客户负责准备工作。
- B 产品的安装和电力连接必须由经授权的服务代理实施。对于由未经授权的人员实施的步骤导致的损坏，制造商不承担任何责任。
- A 安装前，目测检查产品是否有任何缺陷。如果有，请勿安装。本产品损坏可能威胁您的安全。
- C 实施安装或清洁步骤后，将本产品放回原位时，确保进水和排水软管以及电源线没有折叠、夹紧或碾压。

适当的安装位置

- 将机器放在坚固的地面上。请勿放置在长绒头地毯或类似表面上。
- 满载时，上下叠放的洗衣机和烘干机总重量大约 180 公斤。将产品放在坚固、平坦，能够承载该重量的地面上！
- 请勿在电源线上放置该产品。
- 请勿在温度可能降低低于 0°C 的位置安装该产品。
- 该产品与其它家具的边缘至少保持 1 cm 距离。

拆除包装紧固件

向后倾斜洗衣机，来拆除包装紧固件。通过拉包装带，拆除包装紧固件。



打开运输锁

- A 取出包装紧固件后，才可以拆卸运输锁。
 - A 操作洗衣机前，应拆卸运输安全螺栓，否则，该产品可能损坏。
1. 使用扳手松开螺栓，直到可以自由旋转（C）。

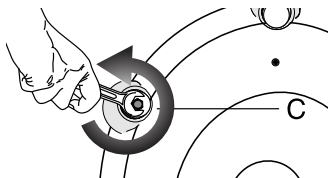

2. 轻轻转动运输安全螺栓，拆卸下来。

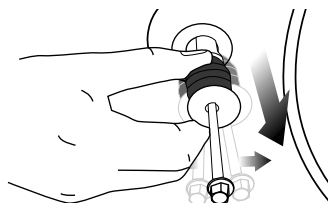

3. 把盖子（和《用户手册》一起装在袋子里）安装到后面板的孔上。（P）

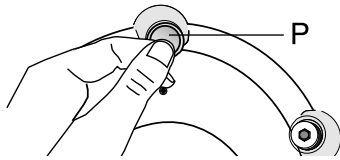

- C 妥善保管运输安全螺栓，以便将来需要再次移动洗衣机时重新使用。
- C 运输安全螺栓没有适当安装在原位时，切勿移动本产品！

连接水源

- C 运行该产品要求的水压为 1 至 10 巴之间 (0.1 - 10 MPa)。洗衣机若要顺利运转，需要在 1 分钟内，有 10-80 升水从全开的水龙头中流出。如果水压较高，使用减压阀。
- C 如果您打算把双进水口洗衣机作为单进水口（冷水）洗衣机使用，必须在热水阀门上安装附带的塞子，才可以进行操作。（适用于配备有盲塞组的产品。）
- C 如果您想使用本产品的两个进水口，可以在取出热水阀门的塞子和垫片组后，连接热水管。（适用于配备有盲塞组的产品。）
- A 单一进水口的型号不应该连接到热水水龙头上。这种情况下，衣物会损坏，或该产品将切换到保护模式，将不工作。
- A 请勿在新产品上使用旧的或用过的进水软管。这可能导致衣物被污染。
- 1. 将该产品附带的专用软管连接到进水阀门上。红色软管（左侧）（最高 90 °C）用于热水入口，蓝色软管（右侧）（最高 25 °C）用于冷水入口。

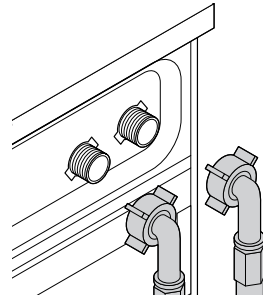

- A 安装该产品时，确保冷热水连接正确。否则，在洗涤过程结束时，出来的衣物很烫，且会磨损。
- 2. 用手拧紧所有软管螺母。上紧螺母时，请勿使用扳手。

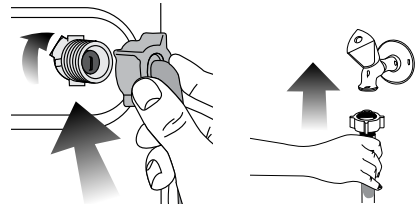

- 3. 连接了软管后，完全打开水龙头，检查连接点是否有任何漏水情形。如果发生任何泄漏，关闭水龙头，并取出螺母。检查密封件后，重新仔细拧紧螺栓。为了防止漏水和导致损坏，洗衣机不使用时，水龙头应保持关闭。

连接排水管

- 排水软管的末端必须直接连接到污水排放口或者脸盆上。
- A 在排水过程中，如果软管从外壳中脱落，可能会淹了您的房子。此外，会因为水温过高导致烫伤！为了防止出现此类情况和确保洗衣机顺利的进水和排水，牢牢固定排水软管的末端，确保不会脱出。
- 软管应该连接至 40 cm 至 100 cm 的高度。
- 将软管平放在地面或者接近地面（距地面高度不足 40 cm）后，如果提

升水管，会导致排水更加困难，且衣物甩干效果差。因此，应遵循图中说明的高度。

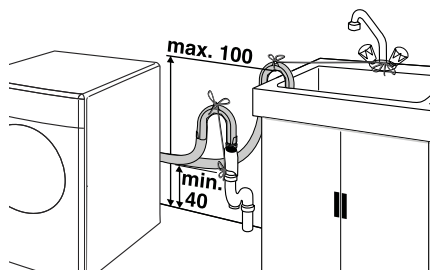

- 为了防止脏水流回到洗衣机和确保容易排水，请勿将软管末端浸入脏水，或者伸入排水口超过 15 cm。如果过长，应剪短。
- 软管末端不得弯曲，不得遭到踩踏，且在排水口与洗衣机之间不得被夹紧。
- 如果软管长度太短，可以使用原装的扩充软管加长。软管长度切勿超过 3.2 m。为了避免发生漏水，扩充软管与本产品排放软管之间的接头必须使用合适的夹子安装好，以免松脱和导致漏水。

调整机脚

A 为了确保产品工作时更为安静和没有振动，其必须水平竖立，且在支腿上保持平衡。通过调整支腿，使机器平衡。否则，该产品可能移动离开原来的位置，导致碾压和振动问题。

1. 用手松开机脚上的锁紧螺母。
2. 调节支腿，直至产品水平站立，并平衡。
3. 用手拧紧所有锁紧螺母。

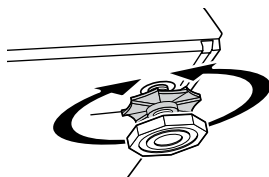

A 请勿使用任何工具松开锁紧螺母。否则，锁紧螺母会受损。

电气连接

将本产品连接到接地插座上，插座应当由符合“技术规范”表中数值的保险丝保护。如果本产品没有根据当地规定，在没有接地的情况下使用，导致的任何损坏，我公司不承担任何责任。

- 连接应符合国家规定。
- 安装后，电源线插头必须在触手可及的范围内。
- 电压和允许使用的保险丝或断路器保护在“技术规范”部分指定。如果家中的保险丝或断路器电流值小

4 准备

节能措施

下列信息将有助于您以环保和高能源效率的方式使用该产品。

- 使用您选择之程序允许的最高容量工作，但不要超载；请参见“程序和能耗表”。
- 始终遵循洗涤剂包装上的说明。
- 在低温下清洗脏污程度较轻的衣物。
- 对于少量轻微脏污的衣物，使用较快速的程序。
- 对于没有严重污染或脏污的衣物，请勿使用预洗和高温洗涤。
- 如果您希望在烘干机烘干衣物，选择洗涤程序建议的最高甩干速度。
- 使用的洗涤剂数量不要超过包装上建议的用量。

给衣物分类

- 根据衣物的纤维类型、颜色，脏污程度以及允许的水温，进行分类。
- 始终遵循衣物标签上的说明。



准备需要洗涤的衣物

- 带有金属配件的衣物，例如胸罩、带扣和金属纽扣，会损坏机器。拆卸金属件，或者将此类衣物放入洗衣袋或枕套中洗涤。



洗衣机根据装入的衣物重量，自动调整水量。

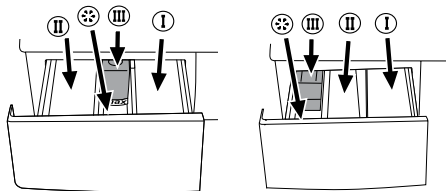

- 取出衣袋中所有物品，例如，硬币、钢笔和回形针，并将衣袋翻出和进行刷洗。此类物品可能损坏洗衣机或导致出现噪声。
- 将小件衣物，例如婴儿的短袜和尼龙长袜放入洗衣袋或枕套内洗涤。
- 放入窗帘时不得挤压。拆卸窗帘上的配件。
- 拉紧拉锁、缝上松脱的纽扣和修补裂口与破缝。
- 只能使用适当的程序洗涤标有“机洗”或“手洗”字样的衣物。
- 彩色和白色衣物应分开洗涤。新的深色棉质衣物可能会严重褪色。请单独洗涤。
- 洗涤前，必须适当处理顽固污渍。如果不确定，可以咨询干洗店。
- 只可以使用适合机洗的染料/改色剂和石灰质去除剂。始终遵循包装上的说明。
- 洗涤裤子和精致衣物时，应把反面朝外。
- 安哥拉羊毛材质的衣物在洗涤前，应在冰箱内放置数小时。这样可以减少起球。
- 受到面粉、石灰尘、奶粉等严重污染的衣物在放入洗衣机前，应抖落这些污染物。长时间过去后，衣物上的此类粉尘和粉末可能沉积在洗衣机内部的零件上，导致损坏。

正确的装载容量

最大负载能力取决于衣物类型、脏污程度和您打算使用的洗涤程序。

A 遵循“程序和能耗表”中的信息。超载时，洗衣机的洗涤性能将下降。此外，可能出现噪声和振动问题。

下表中给出的衣物类型和平均重量仅供参考。

衣物类型	重量（克）
浴袍	1200
餐巾	100
被罩	700
床单	500
枕头套	200
桌布	250
毛巾	200
手巾	100
晚礼服	200
内衣	100
男式工作服	600
男式衬衫	200
男式睡衣	500
长裤	100

装入衣物

- 打开装填门。
- 将衣物零散放入洗衣机。
- 推动装填门关闭之，直至听到锁定的声音。确保装填门没有夹住任何衣物。
- C 程序运行时，装填门是锁定的。只能在程序结束后的一段时间打开装填门。

A 如果放错衣物，洗衣机内可能出现噪声和振动问题。

使用洗涤剂 and 柔顺剂

洗涤剂分送屉

洗涤剂分送屉由三个隔室组成。

- (I) 用来预洗
- (II) 用于主洗
- () 用于柔顺剂
- (*) 此外，在柔顺剂隔间有虹吸管件。

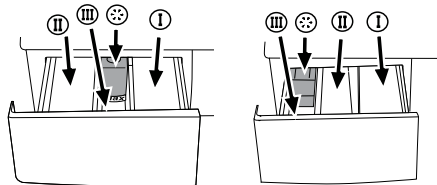

C 如您在前面见到的，根据洗衣机型号，洗涤剂分送屉可以有两种不同的类型。

洗涤剂、柔顺剂和其它清洁剂

- 启动洗涤程序前，加入洗涤剂和柔顺剂。
- 洗涤程序正在运行时，切勿打开洗涤剂分送屉！
- 使用没有预洗功能的程序时，请勿在预洗隔室（隔室编号 I）放入任何洗涤剂。
- 使用带有预洗功能的程序时，请务必在预洗隔室（隔室编号 I）放入液体洗涤剂。
- 如果您使用洗涤剂袋或者分送球，请勿选择带有预洗功能的程序。将洗涤剂袋或分送球随衣物一起放入洗衣机。
- 如果使用液体洗涤剂，请记得将液体洗涤剂杯放在主洗隔间（隔间编号 II）。

选择洗涤剂类型

使用的洗涤剂类型取决于织物类型和颜色。

- 对于彩色和白色衣物，使用不同的洗涤剂。
- 使用适用于高级衣物的专用洗涤剂（液体洗涤剂，羊毛洗衣精，等），洗涤高级衣物。
- 洗涤深色的衣物和棉被时，建议使用液体洗涤剂。
- 使用专用的洗涤剂清洗羊毛织品。

A 只能使用专门制造用于洗衣机的洗涤剂。

A 请勿使用肥皂粉。

调整洗涤剂数量

洗涤剂的用量取决于所洗涤衣物的数量、脏污程度以及水的硬度。阅读洗涤剂包装上制造商提供的说明，并遵循用量值。

- 为了避免泡沫过多、漂洗不彻底，浪费资金以及最终的环保问题，使用的洗涤剂不要超过包装上建议的用量。
- 对于少量或较为干净的衣物使用较少的洗涤剂。
- 在建议的剂量，使用浓缩洗涤剂。

使用柔顺剂

将柔顺剂倒入洗涤剂分送屉的柔顺剂隔间。

- 使用包装上建议的用量。
- 请勿超出柔顺剂隔间上的（> 最高 <）液位标记。
- 如果柔顺剂已经失去流动性，放入洗涤剂分送屉前，应用水稀释。

使用液体洗涤剂

如果产品包含液体洗涤剂杯：

- 确保将液体洗涤剂杯放入隔间号码 "II"。
- 使用洗涤剂制造商提供的量杯，并遵循包装上的说明。
- 使用包装上建议的用量。

- 如果液体柔顺剂已经失去流动性，放入洗涤剂杯前，应用水稀释。

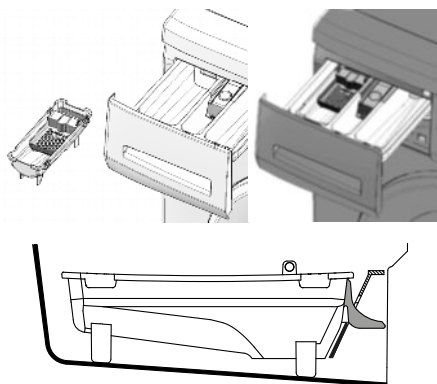

如果产品没有包含液体洗涤剂杯：

- 请勿在带有预洗功能的程序中，在预洗过程使用液体洗涤剂。
- 使用洗涤剂制造商提供的量杯，并遵循包装上的说明。
- 使用“延时启动”功能时，液体洗涤剂会污染您的衣物。如果打算使用“延迟启动”功能，请勿使用液体洗涤剂。

使用凝胶和片状洗涤剂

使用片状、胶状等洗涤剂时，请仔细阅读洗涤剂包装上制造商提供的说明，并遵循用量值。如果包装上没有说明，适用下列内容：

- 如果凝胶状洗涤剂厚度是流体状，且您的洗衣机没有包含专用的液体洗涤剂杯，在初次进水期间，将凝胶状洗涤剂放入主洗的洗涤剂隔间。如果机器带有液体洗涤剂杯，启动程序前，将洗涤剂夹入该杯子。
- 如果凝胶状洗涤剂厚度不是流体状，或者是胶囊液体片剂形状，洗衣前，将其直接放入滚筒中。
- 洗衣前，将片剂洗涤剂放入洗涤剂隔间或者直接放入滚筒中。

- C 片剂洗涤剂可能在洗涤剂隔间有残留物。如果您遇到此类情况，在以

后的洗衣过程中，将片剂洗涤剂放入衣物中间，靠近滚筒下方部分。

- C 使用片剂或凝胶状洗涤剂不得选择预洗功能。

使用浆粉

- 按照包装上的指示，将液体浆粉、粉末浆粉或者染料放到柔顺剂隔室。
- 请勿在洗涤循环中同时使用柔顺剂和浆粉。
- 使用浆粉后，用潮湿和清洁的抹布，擦拭洗衣机内部。

使用漂白剂

- 选择带有预洗功能的程序，并在开始预洗时，添加漂白剂。请勿在预洗隔室放入洗涤剂。作为替代选项，可以选择带有额外漂洗功能的程序，并在第一个漂洗步骤中，洗衣机从洗涤剂隔间进水期间，添加漂白剂。
- 请勿将漂白剂与洗涤剂混合在一起使用。
- 只能使用少量（大约 50 毫升）漂白剂，并彻底漂洗衣物，以免导致皮肤受到刺激。请勿将漂白剂倒在衣物上，且不得用于彩色衣物。
- 使用氧基漂白剂时，请遵循包装上的说明，并选择低温程序。
- 氧基漂白剂可以与洗涤剂一起使用；但是，如果其厚度与洗涤剂不同，首先将洗涤剂放入洗涤剂分送屉的隔间号码 "II" 中，并等待直至洗涤剂在洗衣机进水时流动。在洗衣机仍在进水时，将漂白剂添加到相同的隔间中。

使用水垢去除剂

- 必要时，使用洗衣机专用的水垢去除剂。
- 请始终遵循包装上的说明。

5 选择洗涤程序

控制面板

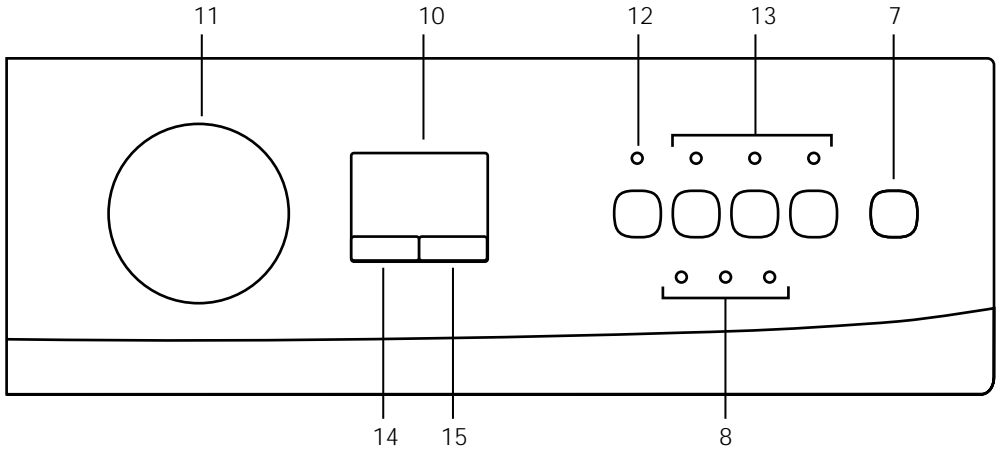

- 7 - “开/关” 按键
 - 8 - “程序运行” 指示灯 “
 - 9 - “童锁” 指示灯 *
 - 10 - 显示屏
 - 11 - “程序选择” 旋钮
 - 12 - 程序选择旋钮
 - 13 - 辅助功能
 - 14 - “预约” 键
 - 15 - “转速调节” 旋钮
- * 视洗衣机型号不同而异



开启机器

机器插上电源。完全打开龙头。检查水管是否连接牢固。放入要洗的衣物。加入洗涤剂 and 柔顺剂。按下“开/关”按键。

程序选择

根据待洗衣物的类型，数量和污渍程度，结合程序表和以下的洗涤温度表格，选择合适的洗涤程序。

90°C	中等污渍，纯白棉织物或亚麻织物（例如：咖啡桌布，餐桌桌布，毛巾，床单）
60°C	中等污渍，不退色的彩色亚麻织物，棉织物，化纤（例如：衬衫，睡衣）； 轻微污渍，纯白亚麻织物（例如：内衣）
40°C-30°C-冷水	精细织物（例如：蕾丝花边织物），混纺（包括化纤和羊毛）织物



用程序选择按键来选择合适的程序。

C 根据衣物的不同种类，选择程序的最高转速，可能有一定的限制。

脱水转速选择

只要选择了一个新的程序，程序的最高转速就会显示在转速指示器上。如要减小转速，按“转速”键。转速会慢慢减少。然后，免排

水和免脱水选择会各自显现。

免排水显示为“”，免脱水显示为“”。

程序结束后，你不想立即取出衣物的话，你可以使用免排水功能，为了防止你的衣服在无水的情况下变皱。用此功能，你的衣物会保留在最后清洗留下的水里。如果你想脱水：

- 调节转速。

- 按“开始/暂停/取消”键。

程序继续。机器开始脱水衣物，排掉余水，并脱水甩干。

你可以使用免脱水功能，只排水，而在程序结束时不进行脱水。

主洗涤程序

取决于待洗衣物的种类，以下主洗涤程序可供选择：

C 当选择程序时，根据待洗衣物的类型，颜色，污渍程度和允许水温，将其分类。

C 在可能的范围内，尽量选择最低的水温。高水温意味着高能耗。

C 请参阅“程序选择表”查看关于各洗涤程序的细节。

• 棉織物程式 HYG&Wash

您可以用该程序洗涤耐穿的衣物。在较长时间的洗涤过程中，将会强劲地洗涤您的衣物。建议用于棉质物品（例如，床单、羽绒被和枕套、被罩、内衣等）。

• 合成织物

您可以用该程序洗涤稍微不耐穿的衣物。与“棉质”程序相比，使用的洗涤动作要温和一些，而且洗涤时间较短。对于合成纤维类衣物（例如衬衫、套衫，合成纤维/棉质混纺衣物等），建议使用此程序。对于窗帘和饰带，建议选择带有预洗和防皱功能的“合成纤维40”程序。

不应该在预洗隔室中放洗涤剂。松散织物（蕾丝）由于其网状结构，会产生很多泡沫，所以，应该在主洗隔室放置少量的洗涤剂。

• 羊毛织物

您可以用该程序洗涤那些可以机洗的毛纺织品衣物。根据衣物的标签，选择合适的洗涤温度。对于毛纺织品衣物，建议使用适当的洗涤剂。

附加程序

对于特殊情况，也可以使用附加程序：

C 根据洗衣机的型号，附加程序可能有所不同。

• HYG&Wash 60

此程序通过更长的加热时间和额外的漂洗循环达到更高卫生要求。洗涤童装及过敏体质人群的衣物时，建议使用此程序。

• 精细织物

您可以用该程式洗涤精緻的衣物。與「合成纖維」程式相比，「柔和」程式的洗滌動作更加靈敏，且中間不用幹。其必須用於建議採用柔和洗滌的衣物。

• Silk&手洗

对于那些带有“不能机洗”标签，而且标签上建议手洗的毛纺织品/精致的衣物，可以使用该程序洗涤。使用该程序洗涤这些衣物时，动作轻柔，不会损坏您的衣物。

• 超级洗

该洗涤程序将在40°C的水温下洗涤更长的时间，洗涤结果将和“棉织物60”类似，但是，可以节能一些。该洗涤程序适用于那些不可用“棉织物60”来洗涤的衣物。

• Refresh (超快速)

该适合快洗（30分钟）小量不是太

脏的衣服。

• 衬衣

您可以使用该程序洗涤棉质、合成纤维和合成纤维混纺的衬衫。

• 运动服

此程序适合洗涤正常方式下穿着较短时间的衣物，例如运动服。用它可以快速洗涤少量的棉质/合成纤维混纺衣物。

• Jean (牛仔褲)

使用该程序，同时洗涤棉质和合成纤维织物，而不需要分类。

专用程序

对于特殊的情形，您可以有以下专用程序供选择：

• 漂洗

如果您想要单独漂洗或浆洗，可以使用该程序。

• 脱水 + 排水

洗衣机里的水排出后，在默认的设置下，该程序使用最大的转速旋转。

C 对于精致衣物，使用稍低的转速。



在开始程序前，按“开始/暂停/取消”键，选择你适合的转速。在漂洗结束后，机器会自动排水。如果你只想排水，而不需要漂洗，选择“高速脱排水”程序，然后用排水速度选择键来选择免脱水。按“开始/暂停/取消”键。

A 请注意针对精细织物而选用较低的脱水转速。

甩干速度选择

每一次选择一个新的程序时，甩干速度指示灯会给出所选程序的最高转速。

按“甩干”按钮可以降低转速。甩干速度就逐渐降了下来。这时，暂停漂洗和无甩干选项会分别显示出来。

暂停漂洗所显示的符号为“”；而无甩干所显示的符号为“”。

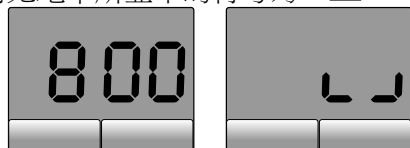

如果在程序完成后并不想立即取出衣物，则可以使用暂停漂洗功能，它能够防止衣物在脱水条件下起皱。使用此功能时，衣物一直保持在最终漂洗水中。当需要甩干保持在水中的衣物时：

- 调节甩干速度。

- 按“启动/暂停/取消”按钮。

原程序就重新启动起来。洗衣机于是排出漂洗水并甩干衣物。

若在程序结束后只需排出洗涤水而无需甩干，则可以使用无甩干功能。

程序选择及耗水耗电量表

ZH					辅助功能					
棉织物程序		最大装载量 (公斤)	耗水量 (升)	能耗 (千瓦时)	预洗	快速洗涤	额外漂洗	防皱免熨	免排水	不可加热
棉織物程式 HYG&Wash	90	8	59	2,20	•	•	•	•	•	•
棉織物程式 HYG&Wash	60**	8	59	1,36	•	•	•	•	•	•
棉織物程式 HYG&Wash	40	8	59	0,80	•	•	•	•	•	•
棉織物程式 HYG&Wash	30	8	59	0.50	•	•	•	•	•	•
超级洗	40	8	59	0,90					•	
HYG&Wash 60	60	8	85	1,30			*	•	•	•
运动服	40	4	37	1,33	•	•	•	•	•	•
衬衣	40	4	50	0,55	•	•	•	•		•
合成织物	60	4	50	0,94	•	•	•	•	•	•
合成织物 (Mix)	40	4	50	0,55	•	•	•	•	•	•
合成织物	30	4	50	0.50	•	•	•	•	•	•
Jean (牛仔褲)	40	4	50	0,55			*	•	•	•
精细织物	30	3	52	0,30			•	•	•	•
羊毛织物	40	2	44	0,20			•		•	•
Silk&手洗	30	1,5	30	0,15						•
Refresh (超快速)	30	3	47	0,20						•

• : 可选

* : 自动设定，不可取消

** : 能耗标签标准程序 (EN 60456)

在实际运行中，在每个洗涤程序中消耗的水和电，会和表格中显示的有出入，这可能由于种种因素：包括水压，水硬度，水温，环境温度，待洗衣物的类型和数量，附加功能的选择与否，甚至电压的波动而有所不同。

❶ 根据机型的不同，表格中所列出的附加功能的种类可能有所不同。

❷ 根据您的选择，程序持续的时间会显示在机器的屏幕上。

附加功能

“附加功能选择”键

C 一些选择不能同时使用。（如：预洗和快洗）

在选择附加功能时，相应的指示灯会亮起。

根据机型的不同，“附加功能选择”键的形式和种类可能有所不同。

附加功能选择

如果所选择的附加功能和之前所设定的某一洗涤步骤相冲突，机器将以最后选择的附加功能为有效，并进而取消之前所设定的那个洗涤步骤。

如果所选择的附加功能和主洗涤程序相冲突，机器将不接受用户的该附加功能选择。请参阅“程序选择表”。

C 附加功能选择键，会因机器型号而有所不同。

• 预洗

选择该功能时，显示屏上“F1”符号将亮起。

- 预洗仅适合脏污程度严重的衣物。不进行预洗可以节省能源、水、洗涤剂和时间。
- 对于饰带和窗帘，建议预洗时不使用洗涤剂。

• 快速洗涤

使用该功能，可以缩短洗涤时间。在显示屏上，“F2”符号将亮起。

- 对于较干净的衣物，使用该功能。
- 建议的装载容量为所选程序最大装载容量的二分之一。

• 额外漂洗

选择该功能时，使用大量水执行洗涤和漂洗。在显示屏上，“F3”符号将亮起。

• 额外加水

选择此功能时，在“棉质”、“合成纤维”、“柔和”和“毛织品”程序使用足量的水进行洗涤和漂洗。

- C 对于容易出现褶皱的精致衣物使用该功能。
- C 每当选择此辅助功能时，投入洗衣机的衣物仅能为程序选择表中最大量的一半。

• 除皱免熨

使用此功能时，滚筒动作会放缓以防止起皱，同时甩干速度也被限制在一定程度上。此外，洗涤也在较高水位进行。在显示屏上，“F4”符号将亮起。

- 对于容易出现褶皱的精致衣物使用该功能。
- C 每当选择此辅助功能时，投入洗衣机的衣物仅能为程序选择表中最大量的一半。

冷水洗

如果您想用冷水洗衣服，可使用该程序。

时间显示

当程序一运行，时间就会显示，直到程序结束。时间显示为小时和分钟，如“01:30”。

C 因水压，水硬度和温度，环境温度，衣物的类型和数量，附加功能的选择，和电压的改变的因素，程序持续时间会和消耗列表中的值有差别。

预约功能

使用“预约”功能，你可以最长预约程序24小时。你可以设置时间延长的步幅，前3个小时，步长是1小时，以后以3小时为步长。如(1, 2, 3,

6, 9, ...24).

C 不要使用液体洗涤剂！那可能会使你的衣物着色。

1. 打开装衣门，放入衣物，装入洗涤剂。
2. 设置洗涤程序，脱水速度，如需要选择附加程序。
3. 按“预约功能”键，调节需要的时间。
4. 按“开始/暂停/取消”键。时间延迟会倒计时。“:”会在显示的时间中间。预约功能会开始闪烁。

C 在时间预约期间，可以加入更多的衣物。

5. 在倒计时结束，“:”会不断闪烁，“就绪”灯会熄灭，根据选择的程序，相关的程序指示会亮起，并开始运行。

改变预约功能

在倒计时的过程中，如果你想改变时间：

1. 按“开始/暂停/取消”键。在屏幕中间的“:”会停止闪烁。
2. 按“时间延迟”键去调节需要的延迟时间。
3. 按“开始/暂停/取消”键。
4. 在屏幕中间的“:”会开始闪烁

取消预约功能

如果你想取消预约功能，直接开始程序：

1. 按“开始/暂停/取消”键。在屏幕中间的“:”会停止闪烁。
2. 按“预约”键去减少预约时间。“0:00”将显示在屏幕上。
3. 按“开始/暂停/取消”键去开始程序。

开始程序

1. 按下“启动/暂停/取消”按键以开始洗涤程序。
2. 表示程序开始的指示灯会亮起。

程序进程

正在运行中的程序的进程是由“程序运行”指示灯组显示。

• 在每个程序的初始，相应阶段的指示灯会亮起，该阶段完成后，指示灯会熄灭。在代表个运行步骤的一系列运行符号的的右方的指示灯会亮起，表示机器正在运行该步骤。

C 如果没有开始脱水，程序可能处在免排水状态或者自动脱水修正平衡系统被激活，因为太多的衣物放置不平衡。

程序启动后的修改

在程序正常的流程中，旋转程序钮，将不会改变程序。

打开机器的待命模式

按“开始/暂停/取消”键来进入待命模式。“开始/暂停/取消”灯开始闪烁。显示机器处于待命模式。

在待命模式中，选择或者取消附加功能，

附加功能可以被取消或选择为与当前程序步骤一致。

在待命模式下增加/取出衣物。

如果水位合适门可以被打开。“就绪”灯会闪烁，直到门允许被打开。当门允许被打开时，“就绪”灯会持续亮起。当门因为安全原因不允许被打开时，“就绪”灯会熄灭。

门锁

当门因为安全原因不允许被打开，同时“就绪”灯会闪烁。当门允许被打开时，“就绪”灯会持续亮起。

儿童安全锁

你可以通过儿童安全锁来保护机器不被儿童玩弄。这样在程序运行时就不能改变它了。同时按第二第三附加功能键3秒钟，儿童安全锁



“C 开” (儿童安全锁激活) 标记显示在屏幕上。当机器开启了儿童安全锁时，按任何键都会显示相同的标记。儿童安全锁激活时，儿童安全锁指示灯会显示。解除儿童安全锁，同时按第二第三附加功能键3秒钟， “C 关” (儿童安全锁解除) 标记显示在屏幕上。儿童安全锁解除时，儿童安全锁指示灯会熄灭。



通过取消结束程序

按“开始/暂停/取消”键3秒钟来取消程序。在取消和“结束”过程中，“就绪”警告灯会出现闪烁显示。

6 维护与清洁

定期清洁该产品，可以延长其使用寿命和减少经常面对的问题。

清洁洗涤剂抽屉

按照下列所示的间隔，定期清洁洗涤剂抽屉，防止长时间过后，粉末洗涤剂聚积。

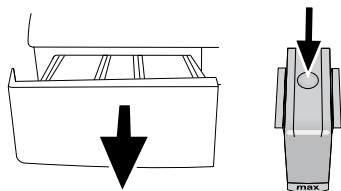

1. 按住柔顺剂隔室中虹吸管上的虚线，并向外拉，直到把隔室从洗衣机上拆卸下来。
- C 如果超过正常数量的水和柔顺剂混合物开始聚集到柔顺剂隔室内，必须清洗虹吸管。
2. 在脸盆中用足量的温水清洗分送屉和虹吸管。清洁时，请佩戴防护手套，或者使用合适的刷子，避免皮肤接触分送屉内的残留物。
3. 清洁后，将分送屉插入到原来的位置，并贴紧。

清洁装填门和滚筒

长时间过后，柔顺剂、洗涤剂和灰尘残留物可能聚积在洗衣机内，导致产生异味和洗衣效果下降。为了避免出现这种情况，使用“清洁滚筒”程序。如果洗衣机没有配备“清洁滚筒”程序，使用“棉质-90”程序，并选择“额外加水”或“辅助漂洗辅助”功能。启动程序前，在主洗清洁剂隔室（隔室编号 II）放入最多 100 克粉末防水垢产品。如果防水垢产品是片剂形式，将一片放入隔室编号 II。程序结束后，用一块清洁的抹布，擦干波纹管内部。

C 每 2 个月重复一次“滚筒清洁”程序。

C 使用适合洗衣机的防水垢产品。每次洗衣后，确保没有异物遗落在滚筒内。

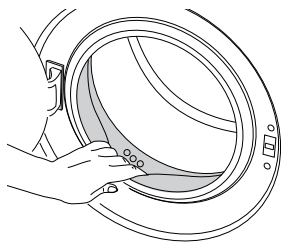

如果图中所示的波纹管中的孔堵塞，使用牙签打开这个孔。

C 洗衣机中的外来金属物质可能导致产生铁锈。使用不锈钢清洁剂清洁滚筒表面的污渍。切勿使用钢丝绒或铁丝绒。

清洁机体和控制面板

用肥皂水或者中性清洁剂，擦拭机体，并用柔软的抹布擦干。

使用柔软的湿抹布清洁控制面板。

A 切勿使用海绵或者擦洗材料。这会损坏喷漆和塑料表面。

清洁进水过滤器。

在洗衣机背面的每个进水阀门末端都有一个过滤器，在连接到水龙头的每根进水软管的末端也有一个过滤器。这些过滤器可以防止异物或水中的污垢进入洗衣机。过滤器脏污后，必须进行清洗。

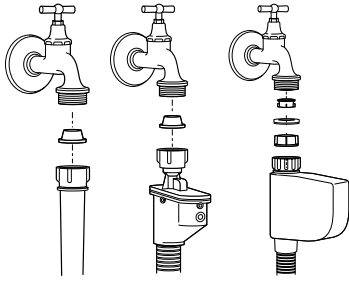

1. 关闭水龙头。
2. 拆卸进水软管的螺母，接近进水阀上的过滤器。用合适的刷子进行清洁。如果过滤器非常脏，您可以用钳子将其取出，并进行清洗。
3. 在进水软管的平直端取下过滤器和垫片，并在流动的清水下面彻底清洗干净。
4. 仔细把垫片和过滤器安装至原来的位置，并用手拧紧软管螺母。

排空所有残留的水，并清洁水泵过滤器

洗衣机中的过滤器系统防止排水过程中，有固体物质堵塞水泵推进器，例如按钮、纽扣和织物纤维。这样，水将毫无问题地排放，并将延长泵的使用寿命。

如果您的洗衣机不能排水，水泵过滤器可能堵塞。每次过滤器堵塞或者每3个月，应该清洁过滤器。清洁水泵过滤器时，水必须排空。

此外，运输机器前（例如，移动到另一间房屋时）和水冻结时，必须完全排出水。

A 水泵过滤器中遗留的异物可能损坏机器或导致出现噪声问题。

清洁脏污的过滤器和排水时：

1. 拔下洗衣机插头，以切断电源。
- A** 洗衣机内的水温可能高达 90 °C。为了避免灼伤危险，必须在洗衣机中的水冷却后，才能清洁过滤器。
2. 打开过滤器盖。

如果过滤器盖由两个零件组成，则可以向下按过滤器盖上的凸钮，并向外拔出。

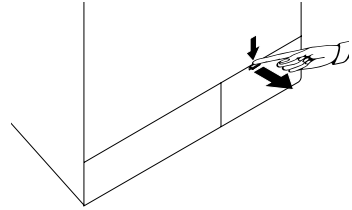

如果过滤器盖是整体式的，在顶部从两边拉动盖子，打开之。

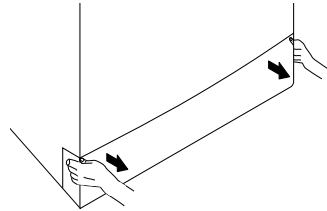

- C** 您可以通过过滤器盖上方的开口，用螺丝刀轻轻地向下推过滤器盖，将其拆卸下来。
3. 某些产品具有紧急排放软管，有些则没有。遵循下列步骤，排放水。在产品具有紧急排放软管时，排放水：

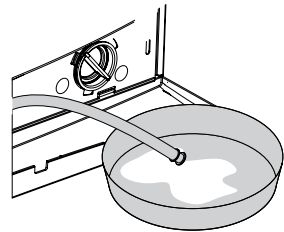

- a. 从底座上拉开紧急排放软管
- b. 在软管末端放置一个大容器。拔下软管末端的插塞，把水排入容器中。容器装满时，放回塞子，堵住软管入口。容器倒空后，重复上述步骤，继续从洗衣机排水。
- c. 完成排水时，再次用插塞关闭末端，并将软管固定住。
- d. 关闭水泵过滤器，将其取出。

在产品没有紧急排放软管时，排放水：

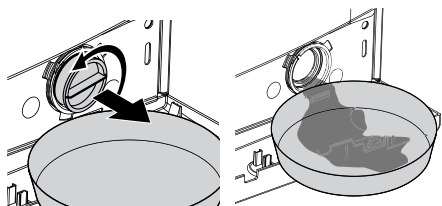

- a. 在过滤器的前方放置一个大容器，以便盛装从过滤器中流出的水。
- b. 松开水泵过滤器（逆时针），直到水开始流出。直接将水排入您放置到过滤器前方的容器中。务必使用手边的抹布吸收溅出的水。
- c. 机器内部的水排空后，转动过滤器，将其完全取出。
4. 清洁过滤器内部的任何残留物和叶轮区域附近的纤维（如果有）。
5. 安装过滤器。
 - A 如果您的洗衣机具有喷水功能，务必把过滤器安装到水泵内的支座上。把过滤器装回原位时，切勿用力。将过滤器在底座上贴紧。否则，水可能从过滤器漏出。
6. 如果过滤器盖由两部分构成，按压凸钮，关闭过滤器盖。如果由一部分构成，将下方部分的凸钮放入到位，并按下上方部分关闭之。

7 故障检修

无法启动或选择程序

- 洗衣机可能因基础设施问题（线电压、水压等）而切换为自我保护模式。>>> 按住“启动/暂停”按钮3秒钟，复位至出厂设置。（请参见“取消程序”）

洗衣机中有水。

- 由于生产中的品质控制过程，产品中可能有水残留。>>> 这并非问题；水对洗衣机无害。

洗衣机底部漏水。

- 软管或水泵过滤器可能有问题。>>> 确保进水软管的密封件牢固安装。将软管牢固连接到水龙头。
- 水泵过滤器可能没有完全关闭。>>> 确保水泵过滤器完全关闭。

洗衣机没有充满水。

- 水龙头关闭。>>> 完全打开水龙头。
- 进水软管弯曲。>>> 展直进水软管。
- 进水过滤器堵塞。>>> 清洁进水过滤器。
- 装填门未关严。>>> 关闭装填门。

洗衣机不排水。

- 排水软管可能堵塞或者扭曲。>>> 清洁或者展直软管。
- 水泵过滤器堵塞。>>> 清洁水泵过滤器。

洗衣机振动或发出噪声。

- 洗衣机可能失衡。>>> 调整支腿，调平洗衣机。
- 可能有坚硬的物体进入水泵过滤器。>>> 清洁水泵过滤器。
- 没有拆除运输安全螺栓。>>> 拆卸运输安全螺栓。
- 洗衣机中的衣物数量太少。>>> 在洗衣机添加更多衣物。
- 洗衣机中装入的衣物可能过多。>>> 从洗衣机中取出一些衣物，或者用手使衣物均匀分布。
- 洗衣机可能靠在坚硬的物体上。>>> 确保洗衣机没有倚靠在任何物体上。

程序启动后不久，洗衣机停止工作。

- 洗衣机可能因为电压过低而临时停止。>>> 电压恢复正常后，洗衣机会继续工作。

洗衣机在进水时直接排水。

- 排水软管的高度可能不够。>>> 按照操作手册中的说明，连接排水软管。

洗涤过程中，看不到洗衣机中的水。

- C 水位从洗衣机外部不可见。这是正常的。

装填门无法打开。

- 由于洗衣机内的水位问题，门锁已经启动。 >>> 通过运转水泵或甩干程序，排放水。
- 洗衣机可能在对水进行加热，或者处于甩干循环。 >>> 等待直至程序完成。
- 儿童锁已经启动。在程序结束后的数分钟后，门锁将解除。 >>> 等待直至门锁解除。

洗涤时间超过手册中指定的时间

- 水压太低。 >>> 洗衣机等待直至进入足量的水，防止因为水量不足导致洗衣效果下降。因此，会延长洗衣时间。
- 电压可能低下。 >>> 在电源电压很低时，会延长洗涤时间，以免洗涤效果不佳。
- 水输入温度可能很低。 >>> 在寒冷的季节，需要时间对水进行加热。此外，也可能延长洗涤时间，以免洗涤效果不佳。
- 可能增加了漂洗次数和/或漂洗用水的数量。 >>> 在需要加强漂洗时，洗衣机会增加漂洗水量，并视需要，增加额外的漂洗步骤。
- 由于使用了过多的洗涤剂，导致出现了过多的泡沫，并可能启动了泡沫自动吸收系统。 >>> 使用建议的洗涤剂量。

C 如果衣物没有均匀地分布在滚筒中，洗衣机就不会切换为甩干步骤，防止对机器和周围环境造成任何损害。重新排列和重新甩干滚筒中的衣物。

程序时间没有倒计时。（在配备显示屏的型号上）

- 进水期间，计时器可能停止。 >>> 在洗衣机进入足量的水之后，计时指示器才会开始倒计时。洗衣机会等待直至水量充足，这样可以避免由于缺水造成的洗涤效果不佳。之后，计时指示器将恢复倒计时。
- 加热期间，计时器可能停止。 >>> 在机器达到选择的温度后，计时指示器才会开始倒计时。
- 甩干期间，计时器可能停止。 >>> 由于衣物在滚筒内分布不均匀，可能启动负载失衡自动检测系统。

C 如果衣物没有均匀地分布在滚筒中，洗衣机就不会切换为甩干步骤，防止对机器和周围环境造成任何损害。重新排列和重新甩干滚筒中的衣物。

程序时间没有倒计时。

- 可能是洗衣机中的衣物失衡。 >>> 由于衣物在滚筒内分布不均匀，可能启动负载失衡自动检测系统。

C 如果衣物没有均匀地分布在滚筒中，洗衣机就不会切换为甩干步骤，防止对机器和周围环境造成任何损害。重新排列和重新甩干滚筒中的衣物。

机器没有切换至甩干步骤。

- 可能是洗衣机中的衣物失衡。 >>> 由于衣物在滚筒内分布不均匀，可能启动负载失衡自动检测系统。

C 如果衣物没有均匀地分布在滚筒中，洗衣机就不会切换为甩干步骤，防止对机器和周围环境造成任何损害。重新排列和重新甩干滚筒中的衣物。

- 如果没有完全排出水，洗衣机将不执行甩干。 >>> 检查过滤器和排水软管。

洗涤效果不佳。衣物变为灰色。

- 长期以来，使用的洗涤剂数量不足。 >>> 使用适合水硬度和衣物的建议洗涤剂用量。
- 长期以来，长时间在低温下洗涤。 >>> 为洗涤的衣物选择适当的温度。
- 在硬水中使用的洗涤剂数量不足。 >>> 在硬水中使用的洗涤剂数量不足，导致污垢粘附在衣物上，长时间过后，会导致衣物变为灰色。一旦出现这种情况，便很难消除。使用适合水硬度和衣物的建议洗涤剂用量。
- 使用的洗涤剂过多。 >>> 使用适合水硬度和衣物的建议洗涤剂用量。
- 没有定期清洁滚筒。 >>> 定期清洁滚筒。对此，请参见“清洁装填门和滚筒”。

洗涤效果不佳。污垢仍然存在或者衣物没有亮白。

- 使用的洗涤剂数量不够。 >>> 使用适合衣物和建议用量的洗涤剂。
- 放入的衣物过多。 >>> 请勿过度装满洗衣机。
- 选择的程序和温度错误。 >>> 为洗涤的衣物选择适当的程序和温度。
- 使用的洗涤剂类型错误。 >>> 使用适合洗衣机的原装洗涤剂。
- 洗涤剂放入错误的隔间。 >>> 在正确的隔间放入洗涤剂。请勿将漂白剂与洗涤剂混合使用。
- 没有定期清洁滚筒。 >>> 定期清洁滚筒。对此，请参见“清洁装填门和滚筒”。

洗涤效果不佳。油渍出现在衣物上。

- 没有定期清洁滚筒。 >>> 定期清洁滚筒。对此，请参见“清洁装填门和滚筒”。

洗涤效果不佳。衣物有异味。

- 由于连续在较低的温度和/或短时程序下洗涤，导致滚筒上形成异味和细菌层。 >>> 在每次洗涤后，洗涤剂分送屉以及装填门应保持微开。这样，便无法在洗衣机内形成适合细菌生长的潮湿环境。
- 没有定期清洁滚筒。 >>> 定期清洁滚筒。对此，请参见“清洁装填门和滚筒”。

衣物褪色。

- 放入的衣物过多。 >>> 请勿过度装满洗衣机。
- 使用的洗涤剂潮湿。 >>> 在干燥的环境密封保存洗涤剂，且不得暴露于高温。
- 选择了较高的温度。 >>> 根据衣物类型和脏污程度，选择合适的程序和温度。
- 没有定期清洁滚筒。 >>> 定期清洁滚筒。对此，请参见“清洁装填门和滚筒”。

没有漂洗好。

- 使用的洗涤剂数量、品牌或贮存条件不合适。 >>> 使用适合洗衣机和衣物的洗涤剂。在干燥的环境密封保存洗涤剂，且不得暴露于高温。
- 洗涤剂放入错误的隔间。 >>> 即使没有选择预洗循环，如果在预洗隔间放入了洗涤剂，洗衣机在漂洗或软化步骤中，仍会消耗洗涤剂。在正确的隔间放入洗涤剂。
- 水泵过滤器堵塞。 >>> 检查过滤器。
- 排水软管被折叠。 >>> 检查排水软管。

洗涤后，衣物变得僵硬。

- 使用的洗涤剂数量不够。 >>> 没有针对水硬度使用足量的洗涤剂可能导致长时间过后，衣物变得僵硬。根据水的硬度，使用合适数量的洗涤剂。
- 洗涤剂放入错误的隔间。 >>> 即使没有选择预洗循环，如果在预洗隔间放入了洗涤剂，洗衣机在漂洗或软化步骤中，仍会消耗洗涤剂。在正确的隔间放入洗涤剂。
- 洗涤剂与柔顺剂混合。 >>> 柔顺剂不得与洗涤剂混合使用。使用热水洗涤和清洁分送屉。
- 没有定期清洁滚筒。 >>> 定期清洁滚筒。对此，请参见“清洁装填门和滚筒”。

衣物没有发出类似柔顺剂的味道。

- 洗涤剂放入错误的隔间。 >>> 即使没有选择预洗循环，如果在预洗隔间放入了洗涤剂，洗衣机在漂洗或软化步骤中，仍会消耗洗涤剂。使用热水洗涤和清洁分送器。在正确的隔间放入洗涤剂。
- 洗涤剂可能与柔顺剂混合。 >>> 柔顺剂不得与洗涤剂混合使用。使用热水洗涤和清洁分送器。
- 没有定期清洁滚筒。 >>> 定期清洁滚筒。对此，请参见“清洁装填门和滚筒”。

洗涤剂分送屉中有洗涤剂残留。

- 洗涤剂放入潮湿的分送屉中。 >>> 放入洗涤剂前，对洗涤剂分送屉进行干燥。
- 洗涤剂可能受潮。 >>> 在干燥的环境密封保存洗涤剂，且不得暴露于高温。
- 水压太低。 >>> 检查水压。
- 主洗隔室中的洗涤剂在预洗进水期间受潮。洗涤剂隔室的孔堵塞。 >>> 检查孔，如果堵塞，予以清洁。
- 洗涤剂分送屉阀有问题。 >>> 致电经授权的服务代理。
- 洗涤剂可能与柔顺剂混合。 >>> 柔顺剂不得与洗涤剂混合使用。使用热水洗涤和清洁分送器。
- 没有定期清洁滚筒。 >>> 定期清洁滚筒。对此，请参见“清洁装填门和滚筒”。

衣物上有洗涤剂残留。

- 放入的衣物过多。 >>> 请勿过度装满洗衣机。
- 选择的程序和温度错误。 >>> 为洗涤的衣物选择适当的程序和温度。
- 使用的洗涤剂错误。 >>> 为洗涤的衣物选择适当的洗涤剂。
- 没有定期清洁滚筒。 >>> 定期清洁滚筒。对此，请参见“清洁装填门和滚筒”。

洗衣机中有过多的泡沫形成。

- 没有针对洗衣机使用合适的洗涤剂。 >>> 使用适合洗衣机的洗涤剂。
- 使用的洗涤剂数量过多。 >>> 只使用足量的清洁剂。
- 洗涤剂贮存条件不当。 >>> 在密闭、干燥的位置存放洗涤剂。请勿在过度炎热的地方存放。
- 一些网状衣物，例如，薄纱，由于结构的问题可能形成过多泡沫。 >>> 对于此类物品，使用较少量的洗涤剂。
- 洗涤剂放入错误的隔间。 >>> 在正确的隔间放入洗涤剂。
- 柔顺剂投入过早。 >>> 阀门或洗涤剂分送屉可能有问题。致电经授权的服务代理。
- 没有定期清洁滚筒。 >>> 定期清洁滚筒。对此，请参见“清洁装填门和滚筒”。

泡沫从洗涤剂分送屉溢出。

- 使用的洗涤剂过多。 >>> 在 $\frac{1}{2}$ 升水中混合 1 汤匙柔顺剂，然后倒入洗涤剂分送屉的主洗隔室。

A 遵循该章节中的说明后，如果仍无法消除该问题，请咨询经销商或授权服务代理。请勿试图自行修理不工作的洗衣机。

Please read this user manual first!

Dear Customer,

We hope that you get the best results from the product which has been manufactured in state-of-the-art plants and passed through a strict quality control procedure.

Therefore, please read the entire user manual carefully before using the product and keep it as a reference for future use. In case of transferring the product to someone else, give the manual as well.

The user manual will help you use your machine in a fast and safe way.

- Read the user manual before installing and starting your product.
- Always follow the safety instructions.
- Keep this user manual within easy reach for future reference.
- Read also the other documents supplied with the product.

Remember that this user manual is also applicable for several other models. Differences between models will be identified in the manual.

Explanation of symbols

Throughout this user manual the following symbols are used:

- C** Important information or useful hints about usage.
- A** Warning for hazardous situations with regard to life and property.
- B** Warning for electric shock.



This appliance's packaging material is recyclable. Help recycle it and protect the environment by dropping it off in the municipal receptacles provided for this purpose. Your appliance also contains a great amount of recyclable material. It is marked with this label to indicate the used appliances that should not be mixed with other waste. This way, the appliance recycling organised by your manufacturer will be done under the best possible conditions, in compliance with European Directive 2002/96/EC on Waste Electrical and Electronic Equipment. Contact your town hall or your retailer for the used appliance collection points closest to your home. We thank you doing your part to protect the environment.

TABLE OF CONTENTS

1 Your washing machine	33	Progress of Programme.....52	
Overview	33	Changing the selections after the Programme has started.....52	
Technical specifications	34	Child-proof lock.....52	
2 Important safety instructions	35	Ending the Programme through canceling.....53	
General safety	35	6 Maintenance and cleaning	54
Intended use	36	Cleaning the detergent drawer.....54	
Children's safety	36	Cleaning the loading door and the drum 54	
3 Installation	37	Cleaning the body and control panel..55	
Appropriate installation location	37	Cleaning the water intake filters	55
Removing packaging reinforcement...37		Draining remaining water and cleaning the pump filter	55
Removing the transportation locks.....37		7 Troubleshooting	58
Connecting water supply	38		
Connecting to the drain	39		
Adjusting the feet.....40			
Electrical connection.....40			
First use	40		
Disposing of packaging material	41		
Transportation of the product.....41			
Disposing of the old product.....41			
4 Preparation	42		
Things to be done for energy saving..42			
Sorting the laundry	42		
Preparing laundry for washing.....42			
Correct load capacity	43		
Loading the laundry	44		
Using detergent and softener	44		
5 Selecting a Programme and operating your machine	47		
Control panel.....47			
Turning the machine on	48		
Programme selection.....48			
Main Programmes	48		
Additional Programmes	48		
Special Programmes	49		
Spin speed selection	49		
Programme selection and consumption table	50		
Auxiliary functions.....51			
Time display	51		
Starting the Programme	52		

1 Your washing machine

Overview

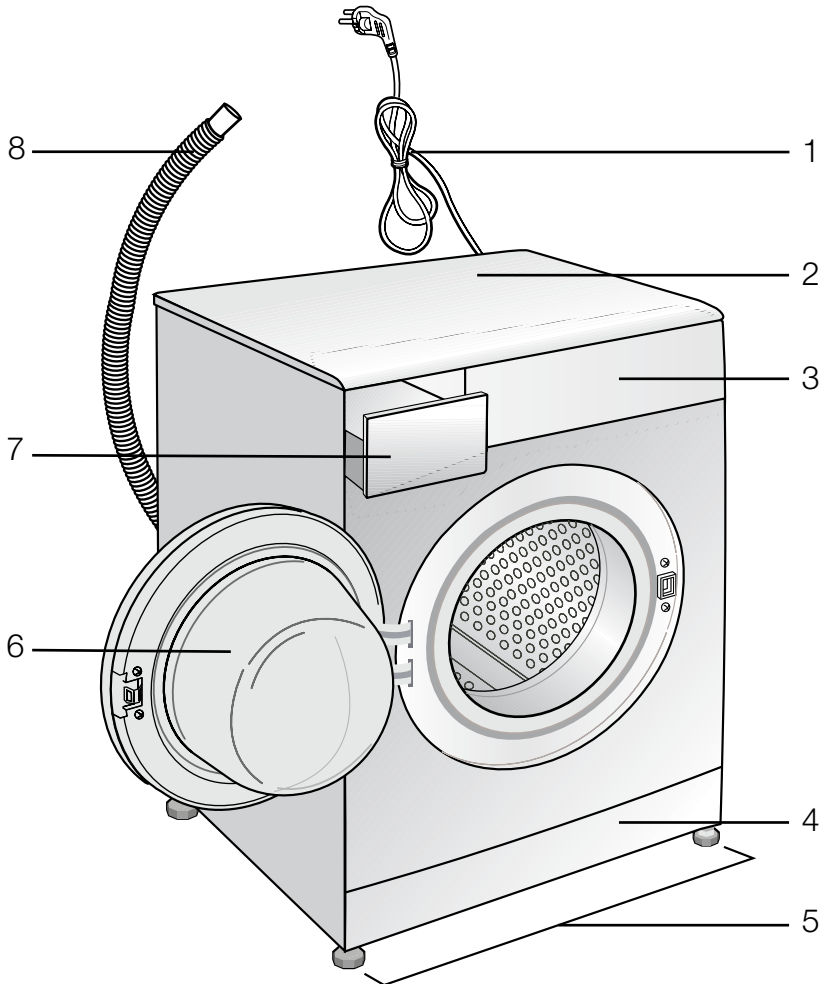

1- Power cable

2- Top panel

3- Control panel

4- Filter cap

5- Adjustable feet

6- Loading door

7- Detergent drawer

8- Drain hose

Technical specifications

Models	WMT 8320	WMT 8320 S
Maximum dry laundry capacity (kg)	8	8
Height (cm)	84	84
Width (cm)	60	60
Depth (cm)	59	59
Net weight (± 4 kg.)	73	73
Electrical input (V/Hz)	220 V / 60Hz	220 V / 60Hz
Total current (A)	9,5	9,5
Total power (W)	1850	1850
Spin speed (rpm max.)	1200	1200

- C Technical specifications may be changed without prior notice to improve the quality of the product.
- C Figures in this manual are schematic and may not match the product exactly.
- C Values stated on the product labels or in the documentation accompanying it are obtained in laboratory conditions in accordance with the relevant standards. Depending on operational and environmental conditions of the product, these values may vary.

2 Important safety instructions

This section contains safety instructions that will help protect from risk of personal injury or property damage. Failure to follow these instructions shall void any warranty.

General safety

- This product should not be used by persons with physical, sensory or mental disorders or unlearned or inexperienced people (including children) unless they are attended by a person who will be responsible for their safety or who will instruct them accordingly for use of the product.
- Never place the product on a carpet-covered floor; otherwise, lack of airflow beneath the machine will cause electrical parts to overheat. This will cause problems with your product.
- Do not operate the product if the power cable / plug is damaged. Call the Authorized Service Agent.
- Have a qualified electrician connect a 16-Ampere fuse to the installation location of the product.
- If the product has a failure, it should not be operated unless it is repaired by the Authorized Service Agent. There is the risk of electric shock!
- This product is designed to resume operating in the event of powering on after a power interruption. If you wish to cancel the programme, see "Cancelling the programme" section.
- Connect the product to a grounded outlet protected by a fuse complying with the values in the "Technical specifications" table. Do not neglect to have the grounding installation made by a qualified electrician. Our company shall not be liable for any damages that will arise when the product is used without grounding in accordance with the local regulations.
- The water supply and draining hoses must be securely fastened and remain undamaged. Otherwise, there is the risk of water leakage.
- Never open the loading door or remove the filter while there is still water in the drum. Otherwise, risk of flooding and injury from hot water will occur.
- Do not force open the locked loading door. The loading door will be ready to open just a few minutes after the washing cycle comes to an end. In case of forcing the loading door to open, the door and the lock mechanism may get damaged.
- Unplug the product when not in use.
- Never wash the product by spreading or pouring water onto it! There is the risk of electric shock!
- Never touch the plug with wet hands! Never unplug by pulling on the cable, always pull out by grabbing the plug.
- Use detergents, softeners and supplements suitable for automatic washing machines only.
- Follow the instructions on the textile tags and on the detergent package.
- The product must be unplugged during installation, maintenance, cleaning and repairing procedures.
- Always have the installation and repairing procedures carried out

by the Authorized Service Agent. Manufacturer shall not be held liable for damages that may arise from procedures carried out by unauthorized persons.

Intended use

- This product has been designed for domestic use. It is not suitable for commercial use and it must not be used out of its intended use.
- The product must only be used for washing and rinsing of laundry that are marked accordingly.
- The manufacturer waives any responsibility arisen from incorrect usage or transportation.

Children's safety

- Electrical products are dangerous for the children. Keep children away from the product when it is in use. Do not let them to tamper with the product. Use child lock to prevent children from intervening with the product.
- Do not forget to close the loading door when leaving the room where the product is located.
- Store all detergents and additives in a safe place away from the reach of the children.

3 Installation

Refer to the nearest Authorised Service Agent for installation of the product. To make the product ready for use, review the information in the user manual and make sure that the electricity, tap water supply and water drainage systems are appropriate before calling the Authorized Service Agent. If they are not, call a qualified technician and plumber to have any necessary arrangements carried out.

- C Preparation of the location and electrical, tap water and waste water installations at the place of installation is under customer's responsibility.
- B Installation and electrical connections of the product must be carried out by the Authorized Service Agent. Manufacturer shall not be held liable for damages that may arise from procedures carried out by unauthorized persons.
- A Prior to installation, visually check if the product has any defects on it. If so, do not have it installed. Damaged products cause risks for your safety.
- C Make sure that the water inlet and discharge hoses as well as the power cable are not folded, pinched or crushed while pushing the product into its place after installation or cleaning procedures.

Appropriate installation location

- Place the machine on a rigid floor. Do not place it on a long pile rug or similar surfaces.

- Total weight of the washing machine and the dryer -with full load- when they are placed on top of each other reaches to approx. 180 kilograms. Place the product on a solid and flat floor that has sufficient load carrying capacity!
- Do not place the product on the power cable.
- Do not install the product at places where temperature may fall below 0°C.
- Place the product at least 1 cm away from the edges of other furniture.

Removing packaging reinforcement

Tilt the machine backwards to remove the packaging reinforcement. Remove the packaging reinforcement by pulling the ribbon.



Removing the transportation locks

- A Do not remove the transportation locks before taking out the

packaging reinforcement.

- A** Remove the transportation safety bolts before operating the washing machine, otherwise, the product will be damaged.

1. Loosen all the bolts with a spanner until they rotate freely (C).

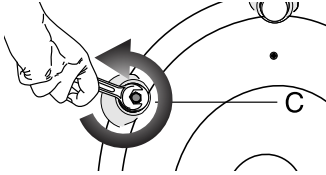

2. Remove transportation safety bolts by turning them gently.

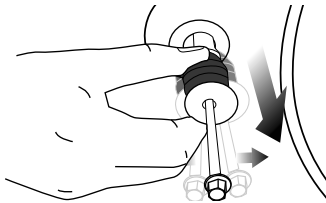

3. Attach the plastic covers supplied in the User Manual bag into the holes on the rear panel. (P)

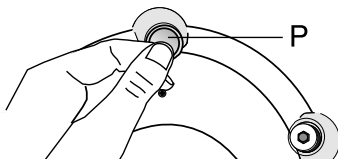

- C** Keep the transportation safety bolts in a safe place to reuse when the washing machine needs to be moved again in the future.
- C** Never move the product without the transportation safety bolts properly fixed in place!

Connecting water supply

- C** The water supply pressure required to run the product is between 1 to 10 bars (0.1 – 10 MPa). It is necessary to have 10 – 80 liters of

water flowing from the fully open tap in one minute to have your machine run smoothly. Attach a pressure reducing valve if water pressure is higher.

- C** If you are going to use the double water-inlet product as a single (cold) water-inlet unit, you must install the supplied stopper to the hot water valve before operating the product. (Applies for the products supplied with a blind stopper group.)

- C** If you want to use both water inlets of the product, connect the hot water hose after removing the stopper and gasket group from the hot water valve. (Applies for the products supplied with a blind stopper group.)

- A** Models with a single water inlet should not be connected to the hot water tap. In such a case the laundry will get damaged or the product will switch to protection mode and will not operate.

- A** Do not use old or used water inlet hoses on the new product. It may cause stains on your laundry.

1. Connect the special hoses supplied with the product to the water inlets on the product. Red hose (left) (max. 90 °C) is for hot water inlet, blue hose (right) (max. 25 °C) is for cold water inlet.

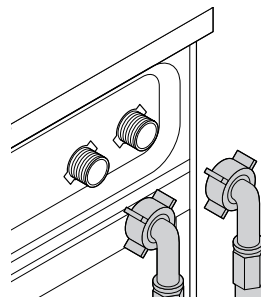

- A Ensure that the cold and hot water connections are made correctly when installing the product. Otherwise, your laundry will come out hot at the end of the washing process and wear out.
2. Tighten all hose nuts by hand. Never use a wrench when tightening the nuts.

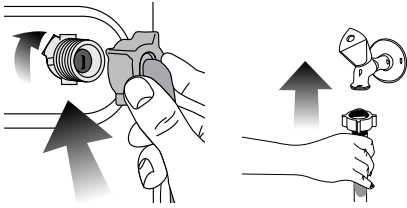

3. Open the taps completely after making the hose connection to check for water leaks at the connection points. If any leaks occur, turn off the tap and remove the nut. Retighten the nut carefully after checking the seal. To prevent water leakages and damages caused by them, keep the taps closed when the machine is not in use.

Connecting to the drain

- The end of the drain hose must be directly connected to the wastewater drain or to the washbasin.
- A Your house will be flooded if the hose comes out of its housing during water discharge. Moreover, there is risk of scalding due to high washing temperatures! To prevent such situations and to ensure smooth water intake and discharge of the machine, fix the end of the discharge hose tightly so that it cannot come out.

- The hose should be attached to a height of at least 40 cm, and 100 cm at most.
- In case the hose is elevated after laying it on the floor level or close to the ground (less than 40 cm above the ground), water discharge becomes more difficult and the laundry may come out excessively wet. Therefore, follow the heights described in the figure.

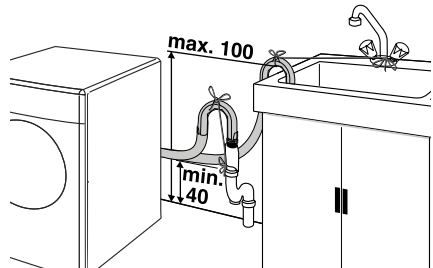

- To prevent flowing of dirty water back into the machine and to allow for easy discharge, do not immerse the hose end into the dirty water or drive it in the drain more than 15 cm. If it is too long, cut it short.
- The end of the hose should not be bent, it should not be stepped on and the hose must not be pinched between the drain and the machine.
- If the length of the hose is too short, use it by adding an original extension hose. Length of the hose may not be longer than 3.2 m. To avoid water leak failures, the connection between the extension hose and the drain hose of the product must be fitted well with an appropriate clamp as not to come off and leak.

Adjusting the feet

- A** In order to ensure that the product operates more silent and vibration-free, it must stand level and balanced on its feet. Balance the machine by adjusting the feet. Otherwise, the product may move from its place and cause crushing and vibration problems.

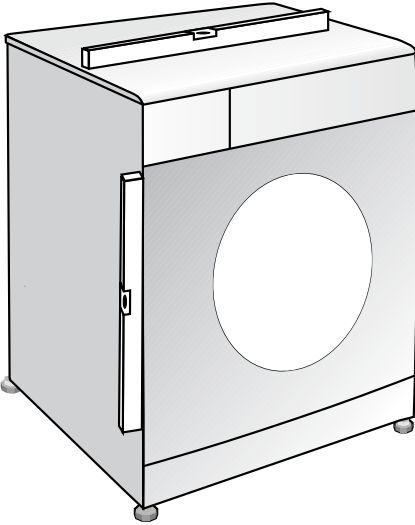

1. Loosen the lock nuts on the feet by hand.
2. Adjust the feet until the product stands level and balanced.
3. Tighten all lock nuts again by hand.

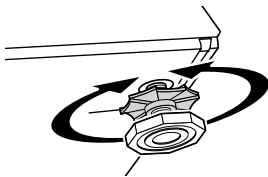

- A** Do not use any tools to loosen the lock nuts. Otherwise, they will get damaged.

Electrical connection

Connect the product to a grounded outlet protected by a fuse complying with the values in the "Technical specifications" table. Our company shall not be liable for any damages that will arise when the product is used without grounding in accordance with the local regulations.

- Connection must comply with national regulations.
- Power cable plug must be within easy reach after installation.
- The voltage and allowed fuse or breaker protection are specified in the "Technical specifications" section. If the current value of the fuse or breaker in the house is less than 16 Amps, have a qualified electrician install a 16 Amp fuse.
- The specified voltage must be equal to your mains voltage.
- Do not make connections via extension cables or multi-plugs.

- B** Damaged power cables must be replaced by the Authorized Service Agents.

First use

Before starting to use the product, make sure that all preparations are made in accordance with the instructions in sections "Important safety instructions" and "Installation".

To prepare the product for washing laundry, perform first operation in Drum Cleaning programme. If your machine is not featured with Drum Cleaning programme, use Cottons-90 programme and select Additional Water or Extra Rinse auxiliary functions as well. Before starting the programme, put max. 100 g of powder anti-limescale into the

main wash detergent compartment (compartment nr. II). If the anti-limescale is in tablet form, put only one tablet into compartment nr. II. Dry the inside of the bellow with a clean piece of cloth after the programme has come to an end.

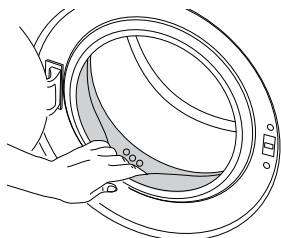

- C Use an anti-limescale suitable for the washing machines.
- C Some water might have remained in the product due to the quality control processes in the production. It is not harmful for the product.

Disposing of packaging material

Packaging materials are dangerous to children. Keep packaging materials in a safe place away from reach of the children.

Packaging materials of the product are manufactured from recyclable materials. Dispose of them properly and sort in accordance with recycled waste instructions. Do not dispose of them with normal domestic waste.

Transportation of the product

1. Unplug the product before transporting it.
2. Remove water drain and water supply connections.
3. Drain the remaining water in the product completely; see, "Draining remaining water and cleaning the pump filter".

4. Install transportation safety bolts in the reverse order of removal procedure; see, "Removing the transportation locks".
- C Never move the product without the transportation safety bolts properly fixed in place!

Disposing of the old product

Dispose of the old product in an environmentally friendly manner.

Refer to your local dealer or solid waste collection centre in your area to learn how to dispose of your product.

For children's safety, cut the power cable and break the locking mechanism of the loading door so that it will be nonfunctional before disposing of the product.

4 Preparation

Things to be done for energy saving

Following information will help you use the product in an ecological and energy-efficient manner.

- Operate the product in the highest capacity allowed by the programme you have selected, but do not overload; see, "Programme and consumption table".
- Always follow the instructions on the detergent packaging.
- Wash slightly soiled laundry at low temperatures.
- Use faster programmes for small quantities of lightly soiled laundry.
- Do not use prewash and high temperatures for laundry that is not heavily soiled or stained.
- If you plan to dry your laundry in a dryer, select the highest spin speed recommended during washing process.
- Do not use detergent in excess of the amount recommended on the detergent package.

Sorting the laundry

- Sort laundry according to type of fabric, colour, and degree of soiling and allowable water temperature.
- Always obey the instructions given on the garment tags.

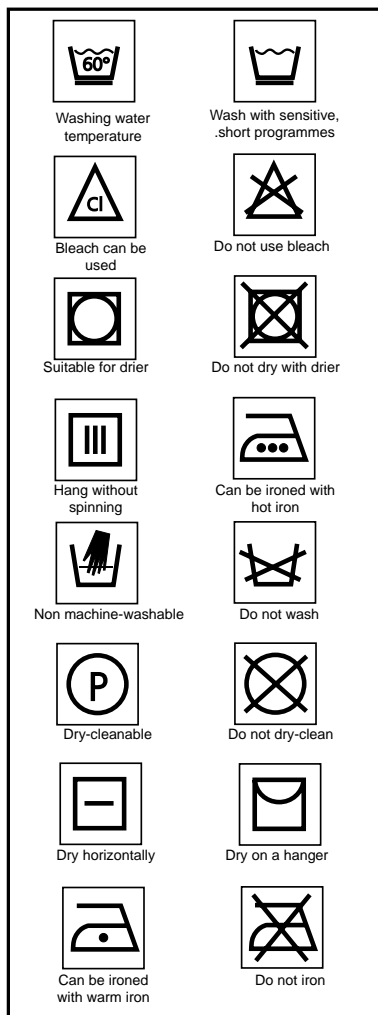

Preparing laundry for washing

- Laundry items with metal attachments such as, underwired bras, belt buckles or metal buttons will damage the machine. Remove the metal pieces or wash the clothes by putting them in a laundry bag or pillow case.



- Take out all substances in the pockets such as coins, pens and paper clips, and turn pockets inside out and brush. Such objects may damage the product or cause noise problem.
- Put small size clothes such as infant's socks and nylon stockings in a laundry bag or pillow case.
- Place curtains in without compressing them. Remove curtain attachment items.
- Fasten zippers, sew loose buttons and mend rips and tears.
- Wash “machine washable” or “hand washable” labeled products only with an appropriate programme.
- Do not wash colours and whites together. New, dark coloured cottons release a lot of dye. Wash them separately.
- Tough stains must be treated properly before washing. If unsure, check with a dry cleaner.
- Use only dyes/colour changers and limescale removers suitable for machine wash. Always follow the instructions on the package.
- Wash trousers and delicate laundry turned inside out.
- Keep laundry items made of Angora wool in the freezer for a few hours before washing. This will reduce pilling.

- Laundry that are subjected to materials such as flour, lime dust, milk powder, etc. intensely must be shaken off before placing into the machine. Such dusts and powders on the laundry may build up on the inner parts of the machine in time and can cause damage.

Correct load capacity

The maximum load capacity depends on the type of laundry, the degree of soiling and the washing programme desired.

The machine automatically adjusts the amount of water according to the weight of the loaded laundry.

- A** Follow the information in the “Programme and consumption table”. When overloaded, machine's washing performance will drop. Moreover, noise and vibration problems may occur.

Laundry types and their average weights in the following table are given as examples.

Laundry type	Weight (g)
Bathrobe	1200
Napkin	100
Duvet cover	700
Bed Sheet	500
Pillowcase	200
Tablecloth	250
Towel	200
Hand towel	100
Evening gown	200
Underclothing	100
Men's overalls	600
Men's shirt	200
Men's pajamas	500
Blouses	100

Loading the laundry

- Open the loading door.
- Place laundry items loosely into the machine.
- Push the loading door to close until you hear a locking sound. Ensure that no items are caught in the door.

C The loading door is locked while a programme is running. The door can only be opened a while after the programme comes to an end.

A In case of misplacing the laundry, noise and vibration problems may occur in the machine.

Using detergent and softener

Detergent Drawer

The detergent drawer is composed of three compartments:

- (I) for prewash
- (II) for main wash
- (III) for softener
- (*) in addition, there is siphon piece in the softener compartment.

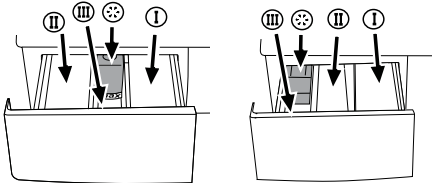

C The detergent dispenser may be in two different types according to the model of your machine as seen above.

Detergent, softener and other cleaning agents

- Add detergent and softener before starting the washing programme.
- Never open the detergent drawer while the washing programme is running!

- When using a programme without prewash, do not put any detergent into the prewash compartment (compartment nr. I).
- In a programme with prewash, do not put liquid detergent into the prewash compartment (compartment nr. I).
- Do not select a programme with prewash if you are using a detergent bag or dispensing ball. Place the detergent bag or the dispensing ball directly among the laundry in the machine.
- If you are using liquid detergent, do not forget to place the liquid detergent cup into the main wash compartment (compartment nr. II).

Choosing the detergent type

The type of detergent to be used depends on the type and colour of the fabric.

- Use different detergents for coloured and white laundry.
 - Wash your delicate clothes only with special detergents (liquid detergent, wool shampoo, etc.) used solely for delicate clothes.
 - When washing dark coloured clothes and quilts, it is recommended to use liquid detergent.
 - Wash woolens with special detergent made specifically for woolens.
- A** Use only detergents manufactured specifically for washing machines.
- A** Do not use soap powder.

Adjusting detergent amount

The amount of washing detergent to be used depends on the amount of laundry, the degree of soiling and water hardness. Read the manufacturer's

instructions on the detergent package carefully and follow the dosage values.

- Do not use amounts exceeding the dosage quantities recommended on the detergent package to avoid problems of excessive foam, poor rinsing, financial savings and finally, environmental protection.
- Use lesser detergent for small amounts or lightly soiled clothes.
- Use concentrated detergents in the recommended dosage.

Using softeners

Pour the softener into the softener compartment of the detergent drawer.

- Use the dosages recommended on the package.
- Do not exceed the (>max<) level marking in the softener compartment.
- If the softener has lost its fluidity, dilute it with water before putting it in the detergent drawer.

Using liquid detergents

If the product contains a liquid detergent cup:

- Make sure that you have placed the liquid detergent cup in compartment nr. "II".
- Use the detergent manufacturer's measuring cup and follow the instructions on the package.
- Use the dosages recommended on the package.
- If the liquid detergent has lost its fluidity, dilute it with water before putting in the detergent cup.

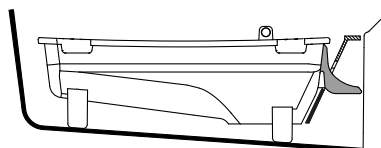
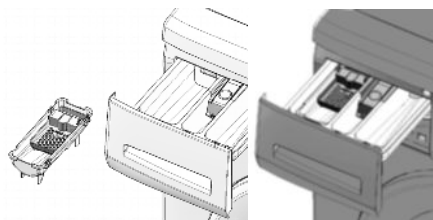

If the product does not contain a liquid detergent cup:

- Do not use liquid detergent for the prewash in a programme with prewash.
- Use the detergent manufacturer's measuring cup and follow the instructions on the package.
- Liquid detergent stains your clothes when used with Delayed Start function. If you are going to use the Delayed Start function, do not use liquid detergent.

Using gel and tablet detergent

When using tablet, gel, etc. detergents, read the manufacturer's instructions on the detergent package carefully and follow the dosage values. If there is not any instruction on the package, apply the following.

- If the gel detergent thickness is fluidal and your machine does not contain a special liquid detergent cup, put the gel detergent into the main wash detergent compartment during first water intake. If your machine contains a liquid detergent cup, fill the detergent into this cup before starting the programme.
- If the gel detergent thickness is not fluidal or in the shape of capsules

liquid tablet, put it directly into the drum before washing.

- Put tablet detergents into the main wash compartment (compartment nr. II) or directly into the drum before washing.

C Tablet detergents may leave residues in the detergent compartment. If you encounter such a case, place the tablet detergent between the laundry, close to the lower part of the drum in future washings.

C Use the tablet or gel detergent without selecting the prewash function.

Using starch

- Add liquid starch, powder starch or the dyestuff into the softener compartment as instructed on the package.
- Do not use softener and starch together in a washing cycle.
- Wipe the inside of the machine with a damp and clean cloth after using starch.

Using bleaches

- Select a programme with prewash and add the bleaching agent at the beginning of the prewash. Do not put detergent in the prewash compartment. As an alternative application, select a programme with extra rinse and add the bleaching agent while the machine is taking water from the detergent compartment during first rinsing step.
- Do not use bleaching agent and detergent by mixing them.
- Use just a little amount (approx. 50 ml) of bleaching agent and rinse the

clothes very well as it causes skin irritation. Do not pour the bleaching agent onto the clothes and do not use it for coloured clothes.

- When using oxygen based bleaches, follow the instructions on the package and select a programme that washes at a lower temperature.
- Oxygen based bleaches can be used together with detergents; however, if its thickness is not the same with the detergent, put the detergent first into the compartment nr. "II" in the detergent drawer and wait until the detergent flows while the machine is taking in water. Add the bleaching agent from the same compartment while the machine is still taking in water.

Using limescale remover

- When required, use limescale removers manufactured specifically for washing machines only.
- Always follow instructions on the package.

5 Selecting a Programme and operating your machine

Control panel

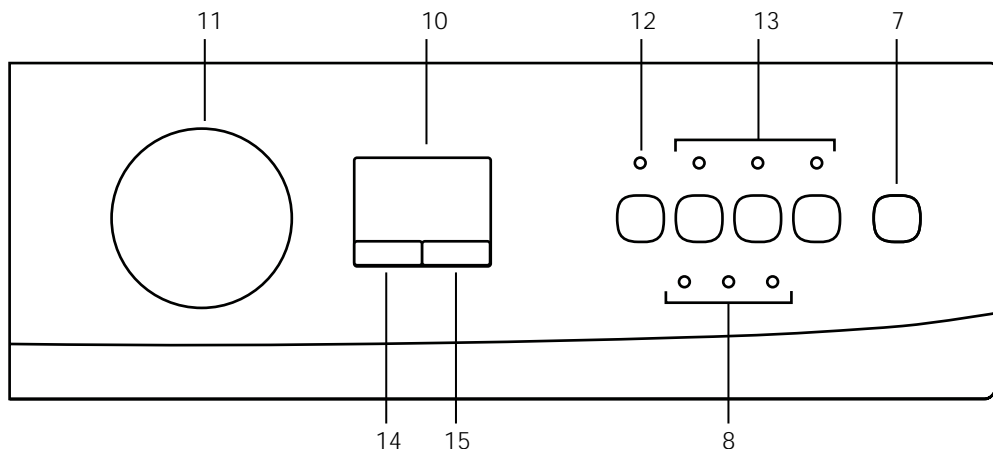

- 7 - On/Off button
- 8 - Programme follower
- 9 - Child proof lock indicator*
- 10 - Display
- 11 - Programme selection knob
- 12 - Start/Pause/Cancel Button
- 13 - Auxiliary Function Buttons
- 14 - Time Delaying Button (+/-)
- 15 - Spin Speed Adjustment Button

* According to your machine's model

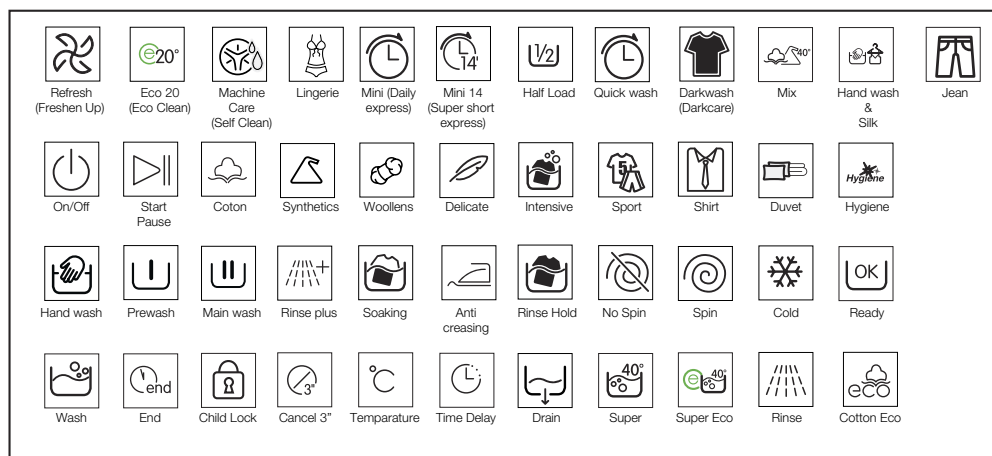

Turning the machine on

Plug in your machine. Turn the tap on completely. Check if the hoses are connected tightly. Place the laundry in the machine. Add detergent and softener. Press the "On/Off" button.

Programme selection

Select the appropriate Programme from the Programme table and the following washing temperature table according to type, amount and degree of soiling of the laundry.

90°C	Normally soiled, white cottons and linens. (Ex.: coffee table covers, tablecloths, towels, bed sheets)
60°C	Normally soiled, fade proof colored linens, cottons or synthetic clothes (Ex.: shirts, nightgowns, pajamas) and lightly soiled white linen clothes (Ex.: underwear)
40°C-30°C-Cold	For delicate clothes (Ex.: lace curtains), blended clothes including synthetics and woolens.

Select the desired Programme with the Programme selection button.

- C Programmes are limited with the highest spin speed appropriate for that particular type of cloth.

Main Programmes

Depending on the type of textile, the following main Programmes are available:

Each of these main Programmes comprise of a complete washing process, including washing, rinsing and, if required, spin cycles.

- C Sort the laundry according to type of fabric, color, degree of soiling and permissible water temperature when choosing a Programme.

- C Always select the lowest required temperature. Higher temperature means higher power consumption.

- C For further Programme details, see, "Programme Selection Table"

• Cotton HYG&Wash

You can wash your durable clothes with this Programme. Your laundry will be washed with vigorous washing movements during a longer washing cycle. It is recommended for your cotton items (such as bed sheets, duvet and pillowcase sets, bathrobes, underclothing, etc.).

• Synthetics

You can wash your less durable clothes on this Programme. Gentler washing movements and a shorter washing cycle is used compared to the "Cottons" Programme. It is recommended for your synthetic clothes (such as shirts, blouses, synthetic/cotton blended garments, etc.). For curtains and lace, the "Synthetic (duo)40" Programme with pre-wash and anti-creasing functions selected is recommended. Detergent should not be put in the pre-wash compartment. Less detergent should be put in the main wash compartment as loose knit fabrics (lace) foam too much due to its meshed structure.

• Woollens

You can wash your machine-washable woolen garments on this Programme. Wash by selecting the proper temperature according to the labels of your clothes. It is recommended to use appropriate detergents for woolens.

Additional Programmes

For special cases, there are also extra Programmes available:

- C Additional Programmes may differ according to the model of your machine.

• HYG&Wash 60

Increased hygiene is provided by a longer heating period and an additional rinse cycle. It is recommended for baby clothes and clothes worn by people with allergies.

- **Delicate**

You can wash your delicate clothes on this Programme. It has more sensitive washing movements and does not make intermediate spinning compared to "Synthetic" Programme. It must be used for clothes for which sensitive washing is recommended.

- **Hand wash&Silk**

You can wash your woolen/delicate clothes that bear "not machine-washable" labels for which hand wash is recommended on this Programme. It washes the laundry with very tender washing movements without damaging your clothes.

- **Refresh**

This Programme is used to quickly wash (30 minutes) a small amount of lightly soiled cotton garments.

- **Super**

This Programme washes for a longer period at 40°C and gives the same result as the "Cottons 60°C" Programme, thus it saves energy. It is suitable for clothes for which you cannot use the "Cottons 60°C" Programme.

- **Shirts**

You can use this Programme to wash cottons and synthetics together. There is no need to sort them.

- **Sports**

This Programme is suitable for clothes that are normally worn for a short time such as sportswear. It is used to quickly wash a small amount of cotton/synthetic blended clothes.

- **Jean**

Use this programme to wash your cotton and synthetic clothes together without sorting them.

Special Programmes

For specific applications, you can select any of the following Programmes:

- **Rinse**

This Programme is used when you want to rinse or starch separately.

- **Spin + Drain**

This Programme is used to apply an additional spin cycle for the laundry or to drain the water in the machine.

Before starting this Programme, select the desired spin speed and press "Start/

Pause/Cancel" button. Your machine drains the water after spinning at the set spin speed.

If you only want to drain the water without spinning your laundry, select "Spin and Pump" Programme, and then select no spin function with spin speed selection button. Press "Start/Pause/Cancel" button.

A You should use a lower spin speed for delicate laundries.

Spin speed selection

Whenever a new Programme is selected, the maximum spin speed of the selected Programme is displayed on the spin speed indicator.

To decrease the spin speed, press the "Spin" button. Spin speed decreases gradually. Then, rinse hold and no spin options are shown respectively.

Rinse hold is shown with "L_" and no spin is shown with "--" symbols.

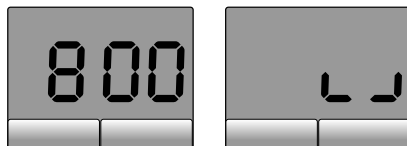

If you do not want to unload your clothes immediately after Programme, you may use rinse hold function in order to prevent your clothes become wrinkled in anhydrous conditions. With this function, your laundry is kept in the final rinsing water. If you want to spin your laundry that you left in water:

- Adjust the spin speed.
- Press "Start/Pause/Cancel" button. Programme resumes. Your machines drains the water and spins your laundry. You can use no spin function in order to drain the water without spinning at the end of the Programme.

Programme selection and consumption table

EN					Auxiliary functions					
Programme		Max. Load (kg)	Water Consumption (l)	Energy Consumption (kWh)	Prewash	Quick Wash	Rinse Plus	Anti-Creasing	Rinse Hold	No Heat
Cotton HYG&Wash	90	8	59	2,20	•	•	•	•	•	•
Cotton HYG&Wash	60**	8	59	1,36	•	•	•	•	•	•
Cotton HYG&Wash	40	8	59	0,80	•	•	•	•	•	•
Cotton HYG&Wash	30	8	59	0.50	•	•	•	•	•	•
Super	40	8	59	0,90					•	
HYG&Wash 60	60	8	85	1,30			*	•	•	•
Sports	40	4	37	1,33	•	•	•	•	•	•
Shirts	40	4	50	0,55	•	•	•	•		•
Synthetics	60	4	50	0,94	•	•	•	•	•	•
Synthetics (Mix)	40	4	50	0,55	•	•	•	•	•	•
Synthetics	30	4	50	0.50	•	•	•	•	•	•
Jean	40	4	50	0,55			*	•	•	•
Delicate	30	3	52	0,30			•	•	•	•
Woolens	40	2	44	0,20			•		•	•
Hand Wash&Silk	30	1,5	30	0,15						•
Refresh	30	3	47	0,20						•

• : Selectable

* : Automatically selected, not cancellable.

** : Energy Label Programme (EN 60456)

Water and power consumption and Programme duration may differ from the table shown, subject to changes in water pressure, water hardness and temperature, ambient temperature, type and amount of laundry, selection of auxiliary functions, and fluctuations in the supply voltage.

i The auxiliary functions in the table may differ according to the model of your machine.

i Programme duration will be displayed on the screen of your machine according to your selection.

Auxiliary functions

Auxiliary Function Selection Buttons

Select the required auxiliary functions before starting the Programme.

- C Some combinations cannot be selected together. (Ex.: Pre-wash and Quick Wash.

Warning signal on the selected auxiliary function will light up.

Auxiliary function selection

If an auxiliary function that should not be selected together with a previously selected function is chosen, the first selected function will be cancelled and the last auxiliary function selection will remain active.

(Ex.: If you want to select pre-wash first and then quick wash, pre-wash will be cancelled and quick wash will remain active.

Auxiliary function that is not compatible with the Programme cannot be selected. (see, "Programme Selection Table")

- C Auxiliary function buttons may differ according to the model of your machine.

- **Prewash**

A pre-wash is only worthwhile for heavily soiled laundry. Without pre-wash you save energy, water, detergent and time.

- C Pre-wash without detergent is recommended for lace and curtains.

- **Quick Wash**

This function can be used for "Cottons" and "Synthetics" Programmes. It decreases the washing times for lightly soiled laundries and also the number of rinsing steps.

- **Rinse Plus**

With this function, you can increase the number of current rinsing steps. Thus, sensitive skins' risk of being affected by the remainder detergent on the clothes will be decreased.

- **Anti-Creasing**

With this function, drum movement will be lessened to prevent creasing and spinning speed is limited. In addition, washing is carried out at a higher water

level.

- C Use this function for delicate laundries that crease easily.
- C Whenever you select this auxiliary function, load your machine with half of the maximum laundry specified in the Programme table.

- **No Heat**

If you wish to wash your clothes in cold water, you can use this Programme.

Time display

The display shows the time remaining for the Programme to complete while a Programme is running. Time is displayed in hours and minutes as "01:30".

- C Programme duration may differ from the values in the consumption table subject to the changes in the water pressure, water hardness and temperature, ambient temperature, type and amount of laundry, auxiliary functions selected, and changes in the supply voltage.

Time delay

With the "Time delay" function you can delay the Programme start up to 24 hours. Time delay can be set with steps of one hour for the first three hours and with steps of three hours for the remainder (1, 2, 3, 6, 9, ...24).

- C Do not use liquid detergent when you set time delay! There is the risk of staining of the clothes.

1. Open the loading door, place the laundry inside and fill detergent drawer.
2. Set the washing Programme, spin speed and, if required, select the auxiliary functions.
3. Pres "Time Delay" button to adjust the desired time.
4. Press "Start/Pause/Cancel" button. The time delay will start to count down. The ":" in the middle of the displayed time delay will start flashing.

- C More laundry may be loaded during the time delay period.

5. At the end of countdown process, ":" will light up continuously, "Ready" light

will go off and the relevant Programme follow-up light will come on according to the selected Programme.

Changing the delay time

If you want to change the time during the countdown:

1. Press "Start/Pause/Cancel" button. ":" in the middle of the screen will stop flashing.
2. Press "Time Delay" button to adjust the desired time delay.
3. Press "Start/Pause/Cancel" button.
4. The ":" in the middle of the displayed time delay will start flashing.

Canceling the time delay

If you want to cancel the time delay countdown and start the Programme:

1. Press "Start/Pause/Cancel" button. The ":" in the middle of the displayed time delay will stop flashing.
2. Press "Time Delay" button to decrease the time delay. "0:00" will appear on the display.
3. Press "Start/Pause/Cancel" button to start the Programme.

Starting the Programme

1. Press "Start/Pause/Cancel" button to start the Programme.
2. Programme follow-up lamp showing the startup of the Programme will light up.

Progress of Programme

Progress of a running Programme is shown through the Programme follow-up indicator. At the beginning of every Programme step, the relevant indicator lamp will light up and light of the completed step will turn off. The indicator that is lit up at the far right of the series of indicator indicates the step that is being carried out.

- C If the machine is not spinning, the Programme may be in rinse hold mode or the automatic spin correction system has been activated due to an excessive unbalanced distribution of laundry in the machine.

Changing the selections after the Programme has started

Turning the Programme knob while the Programme is in a normal flow will not change the Programme.

Switching the machine to standby mode

Press "Start/Pause/Cancel" button momentarily to switch your machine to the standby mode. "Start/Pause/Cancel" lamp will start flashing to indicate that the machine is switched to standby mode.

Selecting or canceling an auxiliary function in standby mode

Auxiliary functions can be cancelled or selected in accordance with the step the Programme is at.

Adding/removing laundry in standby mode

The door can be opened if the water level is suitable. "Ready" lamp will flash until the door is allowed to open. "Ready" lamp will light up continuously when the door is allowed to open. Laundry may be added / taken out by opening the door. "Ready" lamp goes off if the front door is not allowed to open for safety reasons.

Door lock

The loading door can not be opened yet due to safety reasons while the "Ready" lamp is flashing. The loading door can be opened once the "Ready" lamp starts lighting up continuously.

Child-proof lock

This function protects the appliance from being tampered by children. In this case, all of the buttons are inactive except On/Off button; by On/Off button you can whether stop or resume (while child-lock on) the Programme of your machine.

The machine is switched to child-lock by pressing the 1st and 2nd auxiliary functions for 3 sec. "C on" (Child lock is activated) label appears on the screen.

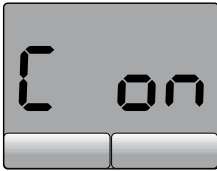

The same symbol will also be displayed whenever any button is pressed while the machine is child-locked. Child-proof lock lamp on the Programme follow-up indicator will light up when the child-proof lock is activated. To deactivate the child-proof lock, press the 1st and 2nd auxiliary function buttons for 3 sec. “C OFF” (Child-proof lock is deactivated) symbol appears on the screen.

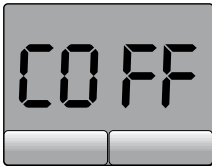

Child-proof lock lamp on the Programme follow-up indicator will go off when the child-proof lock is deactivated.

Ending the Programme through canceling

“Start/Pause/Cancel” button is pressed for 3 seconds to cancel the Programme. “Ready” warning lamp flashes during canceling and “End” will appear on the display.

6 Maintenance and cleaning

Service life of the product extends and frequently faced problems decrease if cleaned at regular intervals.

Cleaning the detergent drawer

Clean the detergent drawer at regular intervals (every 4-5 washing cycles) as shown below in order to prevent accumulation of powder detergent in time.

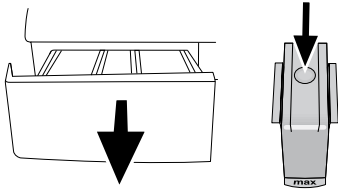

1. Press the dotted point on the siphon in the softener compartment and pull towards you until the compartment is removed from the machine.
 - C If more than normal amount of water and softener mixture starts to gather in the softener compartment, the siphon must be cleaned.
2. Wash the detergent drawer and the siphon with plenty of lukewarm water in a washbasin. Wear protective gloves or use an appropriate brush to avoid touching of the residues in the drawer with your skin when cleaning.
3. Insert the drawer back into its place after cleaning and make sure that it is seated well.

Cleaning the loading door and the drum

Residues of softener, detergent and dirt may accumulate in your machine in

time and may cause unpleasant odours and washing complaints. To avoid this, use the Drum Cleaning programme. If your machine is not featured with Drum Cleaning programme, use Cottons-90 programme and select Additional Water or Extra Rinse auxiliary functions as well. Before starting the programme, put max. 100 g of powder anti-limescale into the main wash detergent compartment (compartment nr. II). If the anti-limescale is in tablet form, put only one tablet into compartment nr. II. Dry the inside of the bellow with a clean piece of cloth after the programme has come to an end.

- C Repeat Drum Cleaning process in every 2 months.
- C Use an anti-limescale suitable for the washing machines.

After every washing make sure that no foreign substance is left in the drum.

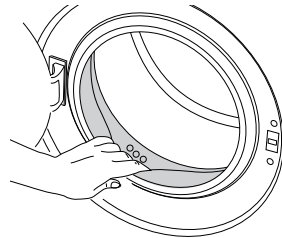

If the holes on the bellow shown in the figure is blocked, open the holes using a toothpick.

- C Foreign metal substances in your machine will cause rust stains. Clean the stains on the drum surface by using cleaning agents for stainless steel. Never use steel wool or wire wool.

Cleaning the body and control panel

Wipe the body of the machine with soapy water or non-corrosive mild gel detergents as necessary, and dry with a soft cloth.

Use only a soft and damp cloth to clean the control panel.

- A Never use sponge or scrub materials. These will damage the painted and plastic surfaces.

Cleaning the water intake filters

There is a filter at the end of each water intake valve at the rear of the machine and also at the end of each water intake hose where they are connected to the tap. These filters prevent foreign substances and dirt in the water to enter the washing machine. Filters should be cleaned as they do get dirty.

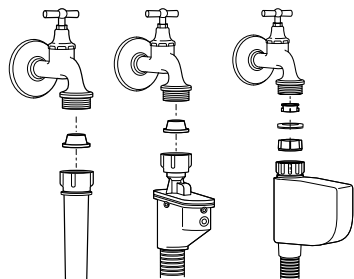

1. Close the taps.
2. Remove the nuts of the water intake hoses to access the filters on the water intake valves. Clean them with an appropriate brush. If the filters are too dirty, take them out by means of pliers and clean them.
3. Take out the filters on the flat ends of the water intake hoses together with the gaskets and clean thoroughly under running water.

4. Replace the gaskets and filters carefully in their places and tighten the hose nuts by hand.

Draining remaining water and cleaning the pump filter

The filter system in your machine prevents solid items such as buttons, coins and fabric fibers clogging the pump impeller during discharge of washing water. Thus, the water will be discharged without any problem and the service life of the pump will extend.

If the machine fails to drain water, the pump filter is clogged. Filter must be cleaned whenever it is clogged or in every 3 months. Water must be drained off first to clean the pump filter.

In addition, prior to transporting the machine (eg., when moving to another house) and in case of freezing of the water, water may have to be drained completely.

- A Foreign substances left in the pump filter may damage your machine or may cause noise problem.

In order to clean the dirty filter and discharge the water:

1. Unplug the machine to cut off the supply power.
- A Temperature of the water inside the machine may rise up to 90 °C. To avoid burning risk, filter must be cleaned after the water in the machine cools down.
2. Open the filter cap.

If the filter cap is composed of two pieces, press the tab on the filter cap downwards and pull the piece out towards yourself.

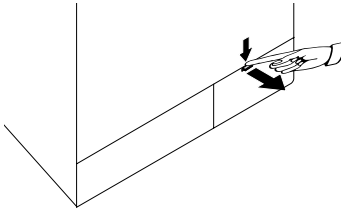

If the filter cap is one piece, pull the cap from both sides at the top to open.

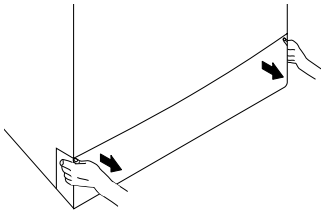

C You can remove the filter cover by slightly pushing downwards with a thin plastic tipped tool, through the gap above the filter cover. Do not use metal tipped tools to remove the cover.

3. Some of our products have emergency draining hose and some does not have. Follow the steps below to discharge the water.

Discharging the water when the product has an emergency draining hose:

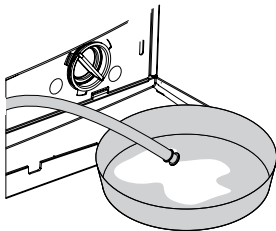

- a. Pull the emergency draining hose out from its seat
- b. Place a large container at the end of the hose. Drain the water into the container by pulling out the plug at the end of the hose. When the container is full, block the inlet of the hose by replacing the plug. After

the container is emptied, repeat the above procedure to drain the water in the machine completely.

- c. When draining of water is finished, close the end by the plug again and fix the hose in its place.
 - d. Turn the pump filter to take it out.
- Discharging the water when the product does not have an emergency draining hose:

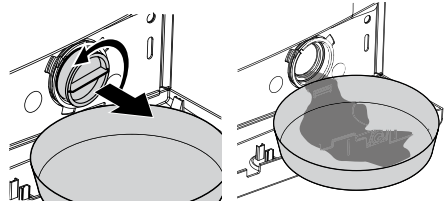

- a. Place a large container in front of the filter to catch water from the filter.
 - b. Loosen pump filter (anticlockwise) until water starts to flow. Fill the flowing water into the container you have placed in front of the filter. Always keep a piece of cloth handy to absorb any spilled water.
 - c. When the water inside the machine is finished, take out the filter completely by turning it.
 4. Clean any residues inside the filter as well as fibers, if any, around the pump impeller region.
 5. Install the filter.
- A** If your product has a water jet feature, be sure to fit the filter into its housing in the pump. Never force the filter while installing it into its housing. Seat the filter into its place completely. Otherwise, water may leak from the filter cap.
6. If the filter cap is composed of two pieces, close the filter cap by pressing on the tab. If it is one piece, seat the tabs in the lower part into

their places first, and then press the upper part to close.

7 Troubleshooting

Programme cannot be started or selected.

- Washing machine has switched to self protection mode due to a supply problem (line voltage, water pressure, etc.). >>> *Press and hold Start / Pause / Cancel button for 3 seconds to reset the machine to factory settings. (See "Canceling the programme")*

Water in the machine.

- Some water might have remained in the product due to the quality control processes in the production. >>> *This is not a failure; water is not harmful to the machine.*

There is water leaking from the bottom of the washing machine.

- Likely problems with hoses or the pump filter. >>> *Be sure the seals of the water inlet hoses are securely fitted. Attach the hose to the tap tightly.*
- Pump filter might not be closed fully. >>> *Make sure that the pump filter is completely closed.*

Machine does not fill with water.

- Tap is turned off. >>> *Open the inlet water taps fully.*
- Water inlet hose is bent. >>> *Flatten the water inlet hose.*
- Water inlet filter is clogged. >>> *Clean the water inlet filter.*
- The loading door is ajar. >>> *Close the Loading Door.*

Machine does not drain water.

- Water drain hose might be clogged or twisted. >>> *Clean or flatten the hose.*
- Pump filter is clogged. >>> *Clean the pump filter.*

Machine vibrates or makes noise.

- Machine might be standing unbalanced. >>> *Adjust the feet to level the machine.*
- A hard substance might have entered into the pump filter. >>> *Clean the pump filter.*
- Transportation safety bolts are not removed. >>> *Remove the transportation safety bolts.*
- Laundry quantity in the machine might be too little. >>> *Add more laundry to the machine.*
- Machine might be overloaded with laundry. >>> *Take out some of the laundry from the machine or distribute the load by hand to balance it homogenously in the machine.*
- Machine might be leaning on a rigid item. >>> *Make sure that the machine is not leaning on anything.*

Machine stopped shortly after the programme started.

- Machine might have stopped temporarily due to low voltage. >>> *It will resume running when the voltage restores to the normal level.*

Machine directly discharges the water it takes in.

- Draining hose might not be at adequate height. >>> *Connect the water draining hose as described in the operation manual.*

No water can be seen in the machine during washing.

C The water level is not visible from outside of the washing machine. This is not a failure.

Loading door cannot be opened.

- Door lock is activated because of the water level in the machine. >>> *Drain the water by running the Pump or Spin programme.*
- Machine is heating up the water or it is at the spinning cycle. >>> *Wait until the programme completes.*
- Child lock is engaged. Door lock will be deactivated a couple of minutes after the programme has come to an end. >>> *Wait for a couple of minutes for deactivation of the door lock.*

Washing takes longer time than the one specified in the manual.

- Water pressure is low. >>> *Machine waits until taking in adequate amount of water to prevent poor washing quality due to the decreased amount of water. Therefore, the washing time extends.*
 - Voltage might be low. >>> *Washing time is prolonged to avoid poor washing results when the supply voltage is low.*
 - Input temperature of water might be low. >>> *Required time to heat up the water extends in cold seasons. Also, washing time can be lengthened to avoid poor washing results.*
 - Number of rinses and/or amount of rinse water might have increased. >>> *Machine increases the amount of rinse water when good rinsing is needed and adds an extra rinsing step if necessary.*
 - Excessive foam might have occurred and automatic foam absorption system might have been activated due to too much detergent usage. >>> *Use recommended amount of detergent.*
- C Machine does not switch to spinning step when the laundry is not evenly distributed in the drum to prevent any damage to the machine and to its surrounding environment. Laundry should be rearranged and re-spun.

Programme time does not countdown. (On models with display)

- Timer may stop during water intake. >>> *Timer indicator will not countdown until the machine takes in adequate amount of water. The machine will wait until there is sufficient amount of water to avoid poor washing results due to lack of water. Timer indicator will resume countdown after this.*
 - Timer may stop during heating step. >>> *Timer indicator will not countdown until the machine reaches the selected temperature.*
 - Timer may stop during spinning step. >>> *Automatic unbalanced load detection system might be activated due to the unbalanced distribution of the laundry in the drum.*
- C Machine does not switch to spinning step when the laundry is not evenly distributed in the drum to prevent any damage to the machine and to its surrounding environment. Laundry should be rearranged and re-spun.

Programme time does not countdown.

- There might be an imbalance of laundry in the machine. >>> *Automatic unbalanced load detection system might be activated due to the unbalanced distribution of the laundry in the drum.*
- C Machine does not switch to spinning step when the laundry is not evenly distributed in the drum to prevent any damage to the machine and to its surrounding environment. Laundry should be rearranged and re-spun.

Machine does not switch to spinning step.

- There might be an imbalance of laundry in the machine. >>> *Automatic unbalanced load detection system might be activated due to the unbalanced distribution of the laundry in the drum.*
- C Machine does not switch to spinning step when the laundry is not evenly distributed in the drum to prevent any damage to the machine and to its surrounding environment. Laundry should be rearranged and re-spun.
- The machine will not spin if water is not drained completely. >>> *Check the filter and the draining hose.*
 - Excessive foam might have occurred and automatic foam absorption system might have been activated due to too much detergent usage. >>> *Use recommended amount of detergent.*

Washing performance is poor: Laundry turns gray.

- Insufficient amount of detergent was used over a long period of time. >>> *Use the recommended amount of detergent appropriate for water hardness and the laundry.*
- Washing was made at low temperatures for a long time over a long period of time. >>> *Select the proper temperature for the laundry to be washed.*
- Insufficient amount of detergent is used with hard waters. >>> *Using insufficient amount of detergent with hard water causes the soil to stick on the cloth and this turns the cloth into gray in time. It is difficult to eliminate graying once it happens. Use the recommended amount of detergent appropriate for water hardness and the laundry.*
- Too much detergent is used. >>> *Use the recommended amount of detergent appropriate for water hardness and the laundry.*
- Regular drum cleaning is not applied. >>> *Clean the drum regularly. For this, please see "Cleaning the loading door and the drum".*

Washing performance is poor: Stains persist or the laundry is not whitened.

- Insufficient amount of detergent is used. >>> *Use recommended amount of detergent appropriate for the laundry.*
- Excessive laundry was loaded in. >>> *Do not load the machine in excess. Load with amounts recommended in the "Programme and consumption table".*
- Wrong programme and temperature were selected. >>> *Select the proper programme and temperature for the laundry to be washed.*
- Wrong type of detergent is used. >>> *Use original detergent appropriate for the machine.*
- Detergent is put in the wrong compartment. >>> *Put the detergent in the correct compartment. Do not mix the bleaching agent and the detergent with each other.*
- Regular drum cleaning is not applied. >>> *Clean the drum regularly. For this, please see "Cleaning the loading door and the drum".*

Washing performance is poor: Oily stains appeared on the laundry.

- Regular drum cleaning is not applied. >>> *Clean the drum regularly. For this, please see "Cleaning the loading door and the drum".*

Washing performance is poor: Clothes smell unpleasantly.

- Odours and bacteria layers are formed on the drum as a result of continuous washing at lower temperatures and/or in short programmes. >>> *Leave the detergent drawer as well as the loading door of the machine ajar after each washing. Thus, a humid environment favorable for bacteria cannot occur in the machine.*
- Regular drum cleaning is not applied. >>> *Clean the drum regularly. For this, please see "Cleaning the loading door and the drum".*

Colour of the clothes faded.

- Excessive laundry was loaded in. >>> *Do not load the machine in excess.*
- Detergent in use is damp. >>> *Keep detergents closed in an environment free of humidity and do not expose them to excessive temperatures.*
- A higher temperature is selected. >>> *Select the proper programme and temperature according to the type and soiling degree of the laundry.*
- Regular drum cleaning is not applied. >>> *Clean the drum regularly. For this, please see "Cleaning the loading door and the drum".*

It does not rinse well.

- The amount, brand and storage conditions of the detergent used are inappropriate. >>> *Use a detergent appropriate for the washing machine and your laundry. Keep detergents closed in an environment free of humidity and do not expose them to excessive temperatures.*
- Detergent is put in the wrong compartment. >>> *If detergent is put in the prewash compartment although prewash cycle is not selected, machine can take this detergent during rinsing or softener step. Put the detergent in the correct compartment.*
- Pump filter is clogged. >>> *Check the filter.*
- Drain hose is folded. >>> *Check the drain hose.*

Laundry became stiff after washing.

- Insufficient amount of detergent is used. >>> *Using insufficient amount of detergent for the water hardness can cause the laundry to become stiff in time. Use appropriate amount of detergent according to the water hardness.*
- Detergent is put in the wrong compartment. >>> *If detergent is put in the prewash compartment although prewash cycle is not selected, machine can take this detergent during rinsing or softener step. Put the detergent in the correct compartment.*
- Detergent might be mixed with the softener. >>> *Do not mix the softener with detergent. Wash and clean the dispenser with hot water.*
- Regular drum cleaning is not applied. >>> *Clean the drum regularly. For this, please see "Cleaning the loading door and the drum".*

Laundry does not smell like the softener.

- Detergent is put in the wrong compartment. >>> *If detergent is put in the prewash compartment although prewash cycle is not selected, machine can take this detergent during rinsing or softener step. Wash and clean the dispenser with hot water. Put the detergent in the correct compartment.*
- Detergent might be mixed with the softener. >>> *Do not mix the softener with detergent. Wash and clean the dispenser with hot water.*
- Regular drum cleaning is not applied. >>> *Clean the drum regularly. For this, please see "Cleaning the loading door and the drum".*

Detergent residue in the detergent drawer.

- Detergent is put in wet drawer. >>> *Dry the detergent drawer before putting in detergent.*
- Detergent has gotten damp. >>> *Keep detergents closed in an environment free of humidity and do not expose them to excessive temperatures.*
- Water pressure is low. >>> *Check the water pressure.*
- The detergent in the main wash compartment got wet while taking in the prewash water. Holes of the detergent compartment are blocked. >>> *Check the holes and clean if they are clogged.*
- There is a problem with the detergent drawer valves. >>> *Call the Authorized Service Agent.*
- Detergent might be mixed with the softener. >>> *Do not mix the softener with detergent. Wash and clean the dispenser with hot water.*
- Regular drum cleaning is not applied. >>> *Clean the drum regularly. For this, please see "Cleaning the loading door and the drum".*

There is detergent left on the laundry.

- Excessive laundry was loaded in. >>> *Do not load the machine in excess.*
- Wrong programme and temperature were selected. >>> *Select the proper programme and temperature for the laundry to be washed.*
- Wrong detergent was used. >>> *Select the proper detergent for the laundry to be washed.*
- Regular drum cleaning is not applied. >>> *Clean the drum regularly. For this, please see "Cleaning the loading door and the drum".*

Too much foam forms in the machine.

- Improper detergents for the washing machine are being used. >>> *Use detergents appropriate for the washing machine.*
- Excessive amount of detergent is used. >>> *Use only sufficient amount of detergent.*
- Detergent was stored under improper conditions. >>> *Store detergent in a closed and dry location. Do not store in excessively hot places.*
- Some meshed laundry such as tulle may foam too much because of their texture. >>> *Use smaller amounts of detergent for this type of item.*
- Detergent is put in the wrong compartment. >>> *Put the detergent in the correct compartment.*
- Softener is being taken early. >>> *There may be problem in the valves or in the detergent dispenser. Call the Authorized Service Agent.*
- Regular drum cleaning is not applied. >>> *Clean the drum regularly. For this, please see "Cleaning the loading door and the drum".*

Foam is overflowing from the detergent drawer.

- Too much detergent is used. >>> *Mix 1 tablespoonful softener and ½ l water and pour into the main wash compartment of the detergent drawer.*
- C Put detergent into the machine suitable for the programmes and maximum loads indicated in the "Programme and consumption table". When you use additional chemicals (stain removers, bleaches and etc), reduce the amount of detergent.

Laundry remains wet at the end of the programme

- Excessive foam might have occurred and automatic foam absorption system might have been activated due to too much detergent usage. >>> *Use recommended amount of detergent.*
- C Machine does not switch to spinning step when the laundry is not evenly distributed in the drum to prevent any damage to the machine and to its surrounding environment. Laundry should be rearranged and re-spun.

A If you cannot eliminate the problem although you follow the instructions in this section, consult your dealer or the Authorized Service Agent. Never try to repair a nonfunctional product yourself.