

**MANUALE D'USO**

IT

**INSTRUCTION MANUAL**

EN

**NOTICE D'UTILISATION**

FR

**GEBRAUCHSANWEISUNG**

DE

**MANUAL DE USO**

ES

**MANUAL DE INSTRUÇÕES**

PT

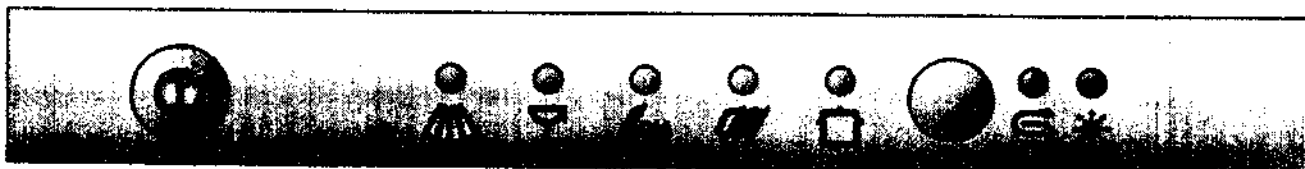

LAVASTOVIGLIE

DISHWASHER

LAVE-VAISSELLE

GESCHIRRSPÜLER

LAVAVAJILLAS

MÁQUINA DE LAVAR LOUÇA

# Contents

EN

1. Safety and operating instructions	32
2. Installation and hook-up	35
3. Description of the controls	37
4. Operating instructions	42
5. Cleaning and maintenance	53
6. Troubleshooting	57

Thank you for choosing this product.

We advise you to carefully read all the instructions contained in this manual, in order to understand how to operate your dishwasher safely and correctly.

The manual is divided into paragraphs, which provide a step by step description of the dishwasher functions, with clear instructions accompanied by detailed illustrations.

Recommendations are given for the correct use of the baskets, spray arms, containers, filters, washing programs, and for operating the controls.

Follow the recommended cleaning procedures to ensure that your dishwasher always remains in perfect working order.

This manual provides a quick and easy reference for answering all your questions concerning the use of your new dishwasher.



**INSTALLATION INSTRUCTIONS:** these are intended for the **qualified technician** who must carry out the installation, hook-up and testing of the appliance.



**USER INSTRUCTIONS:** these consist of recommendations for using the appliance, a description of its controls and of the correct cleaning and maintenance procedures.

## 1. Safety and operating instructions



THIS MANUAL FORMS AN INTEGRAL PART OF THE APPLIANCE: IT MUST ALWAYS BE KEPT INTACT TOGETHER WITH THE DISHWASHER. BEFORE USING THE APPLIANCE, CAREFULLY READ ALL THE INSTRUCTIONS CONTAINED IN THIS MANUAL.

INSTALLATION MUST BE PERFORMED BY A QUALIFIED TECHNICIAN, IN COMPLIANCE WITH THE REGULATIONS IN FORCE. THIS APPLIANCE IS INTENDED FOR DOMESTIC USE, AND COMPLIES WITH THE **EEC DIRECTIVES 72/23, 89/336 (INCLUDING 92/31)** CURRENTLY IN FORCE, INCLUDING THE PREVENTION AND ELIMINATION OF RADIO FREQUENCY INTERFERENCE.

THE APPLIANCE IS DESIGNED FOR THE FOLLOWING PURPOSE: **WASHING AND DRYING OF DISHES**; ANY OTHER USE SHALL BE CONSIDERED IMPROPER. **THE MANUFACTURER DECLINES ALL RESPONSIBILITY FOR USES OTHER THAN THOSE DESCRIBED ABOVE.**



THE NAME PLATE FEATURING THE TECHNICAL DATA, SERIAL NUMBER AND MARKINGS IS VISIBLY POSITIONED ON THE INNER EDGE OF THE DOOR. **THE NAME PLATE ON THE INNER EDGE OF THE DOOR MUST NEVER BE REMOVED.**

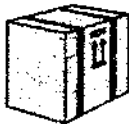

DO NOT LEAVE THE DISCARDED PACKAGING MATERIALS UNSUPERVISED WITHIN THE HOME. SEPARATE THE VARIOUS MATERIALS WHICH MAKE UP THE PACKAGING AND TAKE THEM TO THE NEAREST SORTED WASTE COLLECTION CENTRE.



THE APPLIANCE MUST BE PROVIDED WITH AN EARTH CONNECTION IN ACCORDANCE WITH THE ELECTRICAL SAFETY REGULATIONS IN FORCE. **THE MANUFACTURER DECLINES ALL RESPONSIBILITY FOR DAMAGE TO PERSONS OR PROPERTY RESULTING FROM THE FAILURE TO EARTH THE APPLIANCE OR FROM A DEFECTIVE EARTH CONNECTION.**



IF THE APPLIANCE IS NOT CONNECTED TO THE ELECTRICAL POWER SUPPLY BY MEANS OF A PLUG, IT IS NECESSARY TO INSTALL AN ISOLATION SWITCH WITH A CONTACT OPENING GAP OF AT LEAST 3 MM.



THE PLUG ON THE POWER CORD AND THE CORRESPONDING SOCKET OUTLET MUST BE OF THE SAME TYPE, AND MUST CONFORM TO THE REGULATIONS IN FORCE. CHECK THAT THE VOLTAGE AND FREQUENCY OF THE ELECTRICAL POWER SUPPLY MATCH THE RATINGS ON THE NAME PLATE. AVOID USING ADAPTORS OR SHUNT CONNECTIONS. **NEVER UNPLUG THE APPLIANCE BY PULLING THE POWER CORD.**

# Safety instructions

EN



- AFTER INSTALLATION, THE PLUG MUST REMAIN ACCESSIBLE.
- IN THE EVENT OF DAMAGE TO THE POWER CORD, HAVE IT REPLACED BY A QUALIFIED TECHNICIAN.
- AFTER CHANGING THE POWER CORD, MAKE SURE THAT THE BRACKET WHICH SECURES THE CORD IS FIXED SECURELY IN PLACE.



IF THE APPLIANCE IS INSTALLED ON A CARPETED OR COVERED FLOOR, ENSURE THAT THE OPENINGS ON ITS UNDERSIDE ARE NOT OBSTRUCTED.

ALWAYS SWITCH OFF THE DISHWASHER AFTER EACH USE TO AVOID WASTING ELECTRICITY.



OBSOLETE APPLIANCES MUST BE RENDERED UNUSABLE. CUT OFF THE MAINS POWER CORD AFTER UNPLUGGING IT FROM THE WALL OUTLET, AND MAKE SAFE ANY COMPONENTS WHICH MIGHT BE DANGEROUS FOR CHILDREN (LOCKS, DOORS, ETC.). THE APPLIANCE MUST THEN BE TAKEN TO A SORTED WASTE COLLECTION CENTRE.

IN THE EVENT OF A FAULT, DISCONNECT THE DISHWASHER FROM THE ELECTRICAL POWER SUPPLY AND SHUT OFF THE WATER TAP. THEN CALL IN A QUALIFIED TECHNICIAN.



DO NOT USE APPLIANCES WHICH HAVE BEEN DAMAGED DURING TRANSIT! IF IN DOUBT, CONSULT YOUR DEALER.

THE APPLIANCE MUST BE INSTALLED AND CONNECTED IN ACCORDANCE WITH THE INSTRUCTIONS PROVIDED BY THE MANUFACTURER OR BY A QUALIFIED TECHNICIAN.



**THE APPLIANCE IS INTENDED FOR USE BY ADULTS.** DO NOT ALLOW CHILDREN TO COME NEAR OR PLAY WITH THE DISHWASHER. KEEP CHILDREN AWAY FROM DETERGENTS AND FROM THE OPEN DISHWASHER DOOR. THE PACKAGING MATERIALS (PLASTIC BAGS, POLYSTYRENE, METAL BARS, ETC.) MUST NOT BE LEFT WITHIN THE REACH OF CHILDREN.

KEEP CHILDREN AWAY FROM THE OPEN DISHWASHER. THE APPLIANCE MAY CONTAIN RESIDUES OF DETERGENT WHICH CAN CAUSE IRREVERSIBLE DAMAGE TO THE EYES, MOUTH, AND THROAT, AS WELL AS POSSIBLE DEATH BY SUFFOCATION.

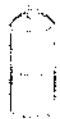

DO NOT INTRODUCE SOLVENTS SUCH AS ALCOHOL OR TURPENTINE WHICH MAY CAUSE AN EXPLOSION.

DO NOT LOAD DISHES THAT ARE SOILED WITH ASH, WAX OR PAINTS.



LEANING OR SITTING ON THE DISHWASHER DOOR WHEN OPEN MAY CAUSE THE APPLIANCE TO OVERTURN, PUTING PEOPLE AT RISK.



DO NOT DRINK THE WATER RESIDUES WHICH MAY BE PRESENT INSIDE THE DISHES OR DISHWASHER AT THE END OF THE WASHING PROGRAM AND BEFORE THE DRYING CYCLE.

#### AQUASTOP MODELS

THE AQUASTOP DEVICE PREVENTS FLOODING IN THE EVENT OF A WATER LEAK. WHEN THE AQUASTOP DEVICE IS TRIPPED, CALL IN A QUALIFIED TECHNICIAN TO IDENTIFY AND REPAIR THE FAULT.

IN MODELS EQUIPPED WITH THE AQUASTOP DEVICE, THERE IS A SOLENOID VALVE INSIDE THE WATER INTAKE HOSE. **DO NOT CUT THE HOSE AND DO NOT ALLOW THE SOLENOID VALVE TO DROP INTO WATER.** IN THE EVENT OF DAMAGE TO THE WATER INTAKE HOSE, DISCONNECT THE APPLIANCE FROM THE ELECTRICAL POWER SUPPLY AND FROM THE WATER SUPPLY.



IMMEDIATELY AFTER INSTALLING THE DISHWASHER, PERFORM A QUICK TEST OF THE APPLIANCE FOLLOWING THE INSTRUCTIONS BELOW. IF THE DISHWASHER FAILS TO OPERATE CORRECTLY, DISCONNECT IT FROM THE ELECTRICAL POWER SUPPLY AND CALL THE NEAREST TECHNICAL SERVICE CENTRE. **DO NOT ATTEMPT TO REPAIR THE APPLIANCE.**



THE DISHWASHER MEETS ALL THE REQUIREMENTS SET OUT BY THE REGULATIONS IN FORCE CONCERNING SAFETY AND ELECTRICAL EQUIPMENT. ANY TECHNICAL CHECKS SHOULD BE CONDUCTED EXCLUSIVELY BY A TRAINED AND AUTHORISED TECHNICIAN: **REPAIRS CARRIED OUT BY UNAUTHORISED PERSONS WILL INVALIDATE THE WARRANTY, AS WELL AS POSING A POTENTIAL HAZARD TO THE USER.**

***The manufacturer declines all responsibility for damage to persons or property resulting from failure to observe the above precautions, from tampering with even a single component of the appliance, or from the use of non original spare parts.***

## 2. Installation and hook-up

Remove the polystyrene basket retainers.

Position the appliance in the desired place of installation. The back or sides of the dishwasher may be placed up against walls or other furniture units. If the dishwasher is installed near a heat source, fit the special insulating panel to prevent overheating and malfunction of the appliance. To ensure stability, install integrated or built-under dishwashers only under continuous worktops, and screw them to the adjacent units. To facilitate the installation procedure, the intake and drain hoses can be positioned in any direction; make sure that the hoses are not kinked, crushed or pulled too tightly.



Level the appliance on the floor using its adjustable feet. This operation is essential for ensuring correct operation of the dishwasher.



*Some models are equipped with only one adjustable foot at the rear, which can be adjusted by turning the screw on the lower front part of the appliance.*

### 2.1 Water supply connection



**Preventing the risk of clogging or damage:** if the water pipe is new or has not been used for a long time, before connecting to the water supply check that the water is clear and free of impurities, to prevent damage to the appliance.

**The dishwasher must always be connected to the water system with new hoses; old or used hoses must never be reused.**

#### CONNECTING TO THE WATER SUPPLY

Connect the intake hose to a cold water supply with  $\frac{3}{4}$ " gas thread, inserting the filter **A** supplied with the dishwasher.

Take care to screw the hose firmly into place with your hands and then complete by tightening about  $\frac{1}{4}$  of a turn with pliers.

In dishwashers equipped with the ACQUASTOP device, the filter is already fitted inside the threaded ring.

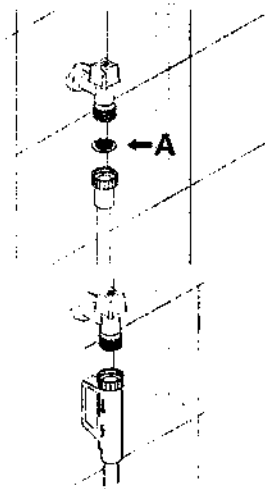



The dishwasher can also be connected to a hot water supply **not exceeding 60°C**. Supplying the appliance with hot water cuts down the washing time by approximately 20 minutes, but slightly reduces its effectiveness. Make the connection to the domestic hot water supply using the same procedure described for connecting to the cold water supply.

### DRAIN CONNECTION

Insert the dishwasher's drain hose into a drain pipe having a diameter of at least **4 cm**, or alternatively, place it inside the kitchen sink using the plastic support provided, taking care not to crush or excessively bend the hose. It is important to prevent the hose from coming loose and falling. For this purpose, the plastic support is equipped with a hole for tying it to the wall or water tap.

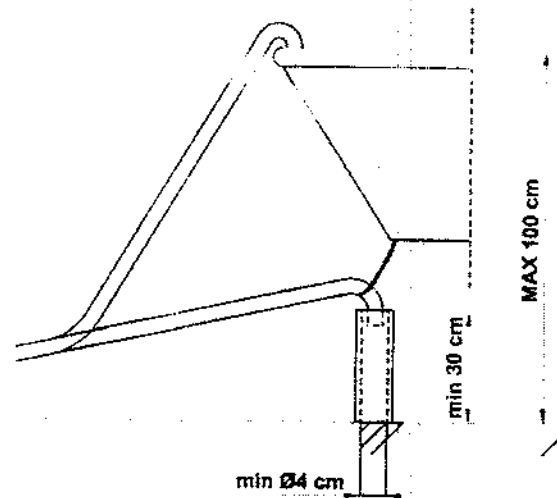

The free end should be positioned at a height of between **30 and 100 cm**, and should never be submerged in water.

If a horizontal drain extension hose is used (for a maximum of 3 m) the drain hose can be placed at a maximum height of **85 cm** from the ground.

### 2.2 Electrical connection

Plug the power cord into a suitable electrical outlet, according to the instructions given in chapter "1. Safety and operating instructions".



## 3. Description of the controls

### 3.1 Upper panel

All the dishwasher controls are grouped on the upper panel.

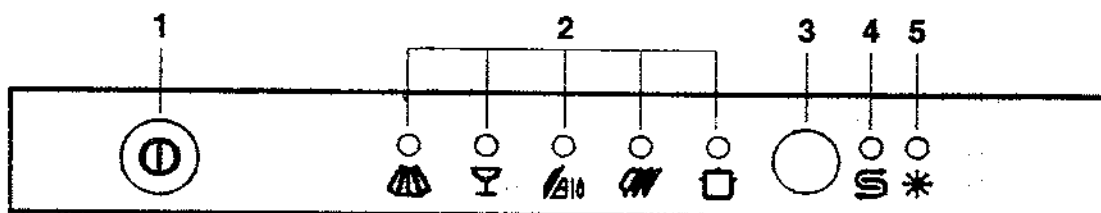

- 1 ON/OFF button**  
Pressing this button energises the appliance.
- SELECTED PROGRAM indicator lights**  
Illumination of this light denotes the program selected and the occurrence of a fault (troubleshooting).
- PROGRAM SELECTION button**  
By pressing this button in sequence it is possible to select the desired program.
- SALT WARNING LIGHT (certain models only)**  
Illumination of this light signals that salt container is empty.
- RINSE AID WARNING LIGHT (certain models only)**  
Illumination of this light signals that rinse aid dispenser is empty.







## SETTING THE WASHING PROGRAM AND SWITCHING ON

To select the most suitable program for the dishes to be washed refer to the table below, which indicates the most appropriate program according to dish type and degree of soiling.

After using the table to identify the most appropriate washing program:

- press the **ON/OFF** button (1) and wait for the **PROGRAM INDICATOR LIGHT (2)** to illuminate;
- keep pressing the **PROGRAM SELECTION** button (3) until the indicator light corresponding to the desired program illuminates;
- close the door; the machine will automatically begin the washing program after the sounding of the acoustic device.

	PROGRAMME, NUMBER & SYMBOL	LOAD CROCKERY AND CUTLERY	PROGRAM PROGRESS
1	 SOAK	Pans and dishes awaiting a further wash	Cold prewash
2	 DELICATE	Wash immediately after use for dishes with light dirt	Wash at 45°C Cold rinse Rinse at 67°C Dry
3	 BIO (*) EN 50242	Wash immediately after use for dishes with normal dirt	Wash at 55°C Cold rinse Rinse at 67°C Dry
	 NORMAL	Dishes with normal dirt	Cold prewash Wash at 65°C Cold rinse Rinse at 67°C Dry
5	 INTENSIVE	Very dirty pans and dishes (except delicate items)	Prewash at 45°C Wash at 67°C 2 cold rinses Rinse at 70°C Dry

Only run the soak program with half loads.

(\*) Reference program as per EN 50242 standard.



# User instructions

EN



*The washing cycle will not take place if the dishwasher door is left open or not properly closed.*

## TABLE FOR CERTIFICATION BODIES

Reference standard	EN 50242
Reference program	BIO
Load	9 place settings
Type of detergent	B
Amount of detergent	25 g
Rinse aid setting	Depending on the model 3/4 or 4/6

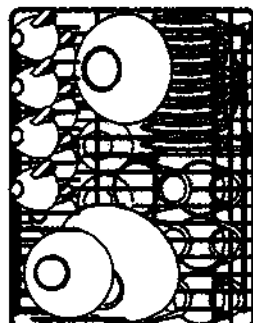
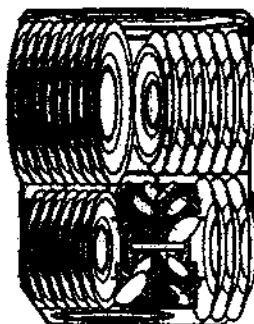

EN 50242



*The upper basket must be set in the low position.*

## 3.2 Washing programs

*Before starting a washing program make sure that:*

- *The water supply tap is open.*
- *The correct amount of detergent has been added to the dispenser.*
- *The baskets have been correctly loaded.*
- *The spray arms are able to rotate freely and without obstruction.*
- *The dishwasher door is securely closed.*

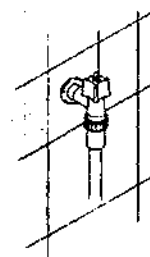

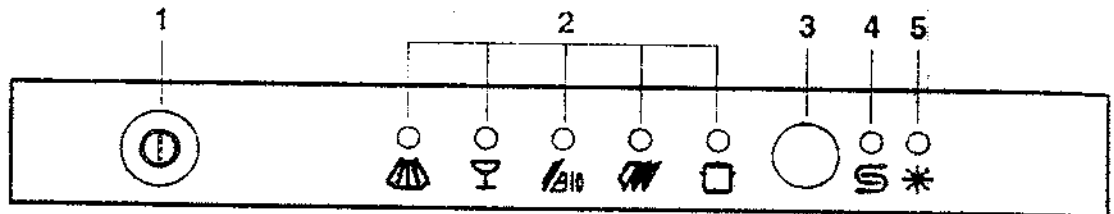

### CANCELLING THE CURRENT PROGRAM

- To cancel the currently selected program, open the door and hold down the **PROGRAM SELECTION (3)** button for a few seconds until the **indicator lights** for programs **4** and **5** illuminate simultaneously.



- Close the door.
- After approximately 1 minute the dishwasher will advance to the end of cycle.

### CHANGING THE PROGRAM

To change the program in progress, simply open the door and select a new program. When the door is closed the dishwasher will automatically select the new program.



## TO SAVE ON ENERGY! ... AND PROTECT THE ENVIRONMENT

- Always try to run the dishwasher **fully loaded**.
- Do not wash the dishes in running water.
- Use the washing program that is **most appropriate** for each type of load.
- Do not carry out any preliminary rinsing.
- If available, connect the dishwasher to a hot water supply up to 60°C.
- When possible, **skip the drying cycle** by leaving the door open when the washing cycle is complete; the air and the residual heat will dry the dishes perfectly.

## TO CUT DOWN ON DETERGENT CONSUMPTION! ... AND PROTECT THE ENVIRONMENT

The phosphates contained in dishwasher detergents are harmful to the environment. To avoid using excessive amounts of detergent and to save on electricity, observe the following:

- **separate** the more delicate items from dishes that are more resistant to aggressive detergents and high temperatures;
- **do not pour** the detergent directly on the dishes.



If it is necessary to open dishwasher door during the washing cycle, there will be a **1-minute delay** before the program can be resumed. After correctly closing the door, the washing program will start again from where it was interrupted. This operation may negatively affect the progress of the washing cycle.

## END OF CYCLE

At the end of the washing cycle, a brief acoustic device is sounded and the **indicator light for the program** which has just ended blinks.

To switch off the dishwasher, open the door and press the **ON/OFF** button (1).

## REMOVING THE DISHES

At the end of the washing program, wait at least **20 minutes** before removing the dishes, to allow them to cool down. To prevent any water droplets on the upper basket from falling on the dishes in the lower basket, it is **advisable** to unload the lower basket first, and then the upper basket.



## 4. Operating instructions

Once the dishwasher has been correctly installed, prepare for use as follows:

- Adjust the water softening system;
- Add the regenerating salt;
- Add the rinse aid and detergent.

### 4.1 Using the water softening system



The amount of scale contained in the water (water hardness index) can cause whitish staining on the dry dishes, which tend to become dull over time. The dishwasher is equipped with an automatic softening system which uses a special regenerating salt to reduce the hardness of the water.

The dishwasher is factory set for water hardness level 3 (average hardness 41-60°dF – 24-31°dH).

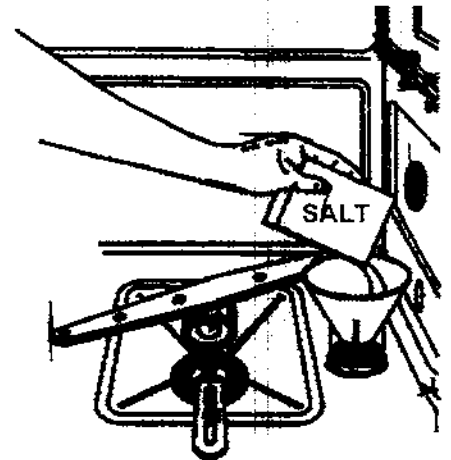

When using water of medium hardness, the regenerating salt container should be refilled after approximately **20 washing cycles**. The salt container can hold approximately **1.5 Kg** of salt in grains. The container is situated at the bottom of the dishwasher. After removing the lower basket, unscrew the salt container cap by turning it anticlockwise and pour in the salt using the funnel supplied with the dishwasher. Before replacing the cap, remove any salt residues from around the opening.



- *When using the dishwasher for the first time, in addition to the salt it is also necessary to add **one litre of water** to the container.*
- *Each time the salt container is refilled, make sure that **the cap is securely closed**. The mixture of water and detergent must never penetrate the salt container, as this would compromise the operation of the regeneration system. In the event of this occurring, the warranty will be invalidated.*
- *Only use regenerating salt specially formulated for domestic dishwashers. If using salt tablets, **do not fill the container completely**.*



- **Do not use table salt** as it contains insoluble substances which, over time, may damage the water softening system.
- **When necessary, refill the regenerating salt container before starting the washing program.** In this way, the excess saline solution will be immediately removed by the water; the prolonged presence of salt water inside the tank may lead to **corrosion**.



**Be careful not to confuse the salt and detergent packages;** adding detergent to the salt container will **damage the water softening system.**

## ADJUSTING THE WATER SOFTENING SYSTEM

The dishwasher is equipped with an device for the user to adjust the water softening system according to the hardness of the water supply.

The setting switch is inside the water softening system underneath the cap, and offers a choice of 5 settings.

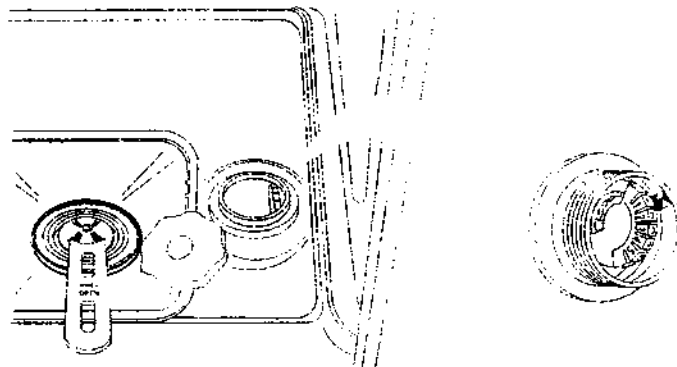



## WATER HARDNESS TABLE

WATER HARDNESS		SETTING
German Degrees (°dH)	French Degrees (°dF)	
0 - 4	0 - 7	Setting N. 1 NO SALT
5 - 9	8 - 15	Setting N. 1
10 - 17	16 - 30	Setting N. 2
18 - 26	31 - 45	Setting N. 3
27 - 35	46 - 60	Setting N. 4
36 - 47	61 - 80	Setting N. 5

Contact your local water board for information on the hardness of your water supply.

### 4.2 Using the rinse aid and detergent dispensers

The detergent and rinse aid dispensers are situated on the inner part of the door: the detergent dispenser is on the left, and the rinse aid dispenser is on the right.

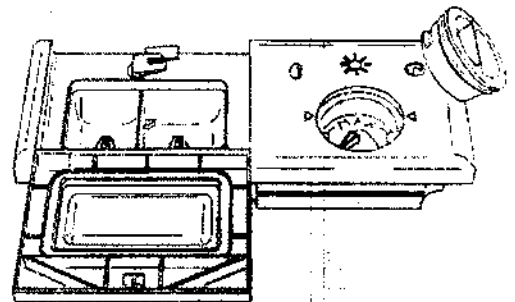

With the exception of the **SOAK** program, before every washing cycle it is necessary to add the required amount of detergent to the **detergent dispenser**. The rinse aid, on the other hand, should only be added as required.

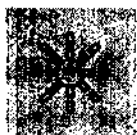

## ADDING THE RINSE AID

The rinse aid helps the dishes dry faster and prevents the formation of scale deposits and staining; it is automatically added to the water during the final rinse cycle, from the container situated on the inner side of the door.

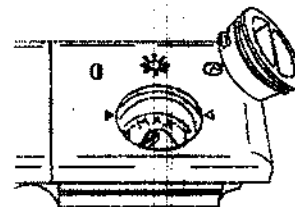

To add rinse aid:

- Open the door.
- Rotate the container cap anticlockwise by  $\frac{1}{4}$  of a turn and remove it.
- Add the rinse aid until the container is full (approximately 140 cc). The optical level indicator on the side of the cap should be completely obscured. Refill the rinse aid when the optical level indicator becomes clear again, or when the rinse aid warning light illuminates.
- Replace the cover and turn it in a clockwise direction.
- Use a cloth to remove any spillage of rinse aid which might lead to the formation of excess foam.

## ADJUSTING THE RINSE AID DISPENSER SETTING

The dishwasher is factory set for medium water hardness. However it is possible to change the setting by turning the dispenser's selector to the desired position: the amount of rinse aid dispensed is proportional to the selector position.

The setting must be increased when the washed dishes appear dull or have circular staining.

- To adjust the rinse aid setting, rotate the dispenser cap through a quarter turn in an anticlockwise direction and remove it.
  - Then use a screwdriver to rotate the rinse aid selector to the desired position.
  - Replace the cap, turning it clockwise.
- The amount of rinse aid must be increased if the washed dishes appear dull or feature circular stains.*
- If, on the other hand, the dishes are sticky or have white streaks, it is necessary to reduce the rinse aid setting.*





### ADDING THE DETERGENT

To open the detergent dispenser cap, lightly press the button **P**. Add the detergent and close the cap carefully.

During the washing cycle, the dispenser will be opened automatically.

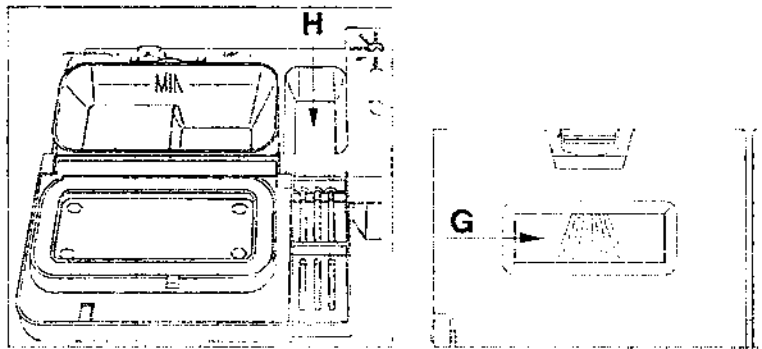

- When a **INTENSIVE** program is selected, in addition to the normal dose of detergent, it is necessary to add an additional amount inside compartment **G** or **H**.
- Use **only** detergents specially formulated for dishwashers. For optimal washing results it is important to use a good quality detergent.
- The detergent packs must be sealed and stored in a dry place to prevent the formation of lumps which may negatively affect washing results. Once opened the detergent packs should not be kept for too long, otherwise the detergent loses its effectiveness.
- Do not use detergents formulated for washing dishes by hand, because they produce a great deal of foam and may negatively affect the operation of the dishwasher.
- Add the correct amount of detergent. An insufficient amount of detergent will result in a partial removal of dirt from the dishes, whereas an excessive amount is wasteful and does not improve the washing results.



- *The market offers liquid and powder detergents with differing chemical compositions, which may contain **phosphates**, or be phosphate-free but contain **natural enzymes**.*

- *Detergents containing **phosphates** are more effective against grease and starch at **temperatures above 60°C**.*

- ***Enzyme** detergents, on the other hand, are also effective at lower temperatures (**from 40 to 55°C**) and are more easily biodegradable. With enzyme detergents it is possible to obtain at low temperatures comparable results to those which can only be achieved at **65°C** using traditional detergents.*

*For the safeguarding of the environment we recommend the use of **phosphate- and chlorine free** detergents.*

- *Also available are tablet detergents which state that that no salt or rinse aid is required. In some cases, these detergents might not give good results, especially with short and/or low-temperature washing cycles.*

*If performance problems (e.g. a white coating on the tank or dishes, poor drying, dirt on dishes at the end of the wash) are noted, users are advised to return to conventional products (granular salt, powder detergent and liquid rinse aid).*

*However, please note that on return to the use of conventional salt, a number of cycles will be required before the system becomes fully efficient again, so traces of white coating may still be found on the tank and dishes. If the problem persists for too long, contact the After-Sales Service.*



***The introduction of detergent into the rinse aid dispenser, even in liquid form, will damage the dishwasher.***



### 4.3 General warnings and recommendations



Before using the dishwasher for the first time, it is advisable to read the following recommendations concerning dish types to be washed and their loading.

There are generally no constraints on the washing of domestic dishes, but in certain cases it is necessary to take their characteristics into account.

Before loading the dishes into the baskets it is necessary to:

- remove coarse food remains: e.g. bones, fish-bones, etc. which may clog the filter or damage the wash pump.
- soak any pots or pans with burnt-on food remains on the bottom to facilitate removal, then load them into the LOWER BASKET.

There is no need to pre-wash the dishes under running water before loading them into the baskets since this only wastes water.

**Correct loading of the dishes helps ensure optimal washing results.**

#### **WARNING!**

- Make sure that the dishes are securely in place so that they cannot tip over or obstruct the rotation of the spray arms during the washing cycle.
- Do not place very small objects in the baskets as these could fall and obstruct the spray arms or the wash pump.
- Containers such as cups, bowls, glasses and pots should always be loaded with the opening facing downwards and with any cavities at an angle, to allow the water to drain out.
- Do not stack dishes or place them in such a way that they cover one other.
- Do not place glasses too close together because they may knock against each other and break, or there might be staining at the point where they touch.

**MAKE SURE** that the items being washed are dishwasher-safe.



## **Items which are not dishwasher-safe:**

- **Wooden dishes, pots or pans:** these may be damaged by the high washing temperatures.
- **Handcrafted items:** these are rarely suitable for washing in a dishwasher. The relatively high water temperatures and the detergents used may damage them.
- **Plastic dishes:** these are not heat resistant and may lose their shape. Heat resistant plastic dishes must be washed in the upper basket.
- **Dishes and objects in copper, tin, zinc or brass:** these tend to stain.
- **Aluminium dishes:** items made from anodised aluminium may lose their colour.
- **Silverware:** silver items may stain.
- **Glass and crystal:** in general, glass and crystal objects can be washed in the dishwasher. However, certain types of glass and crystal may become dull and lose their clearness after many washings. Therefore, for these items we recommend using the least aggressive program available.
- **Decorated items:** the decorated objects available on the market are generally able to withstand washing in the dishwasher, although the colours may fade after a great many washes. If in doubt as to the fastness of the colours, it is advisable to wash just a few items at a time for approximately one month.



#### 4.4 Using the baskets

The dishwasher has a capacity of **9 place-settings**, including serving dishes.

##### LOWER BASKET

The lower basket receives the full force of the lower spray arm, and should therefore be used for the "toughest" items with a heavier degree of soiling.

All types and combinations of loads are permitted, provided that the dishes, pots and pans are arranged with all the soiled surfaces exposed to the water jets coming from the bottom.

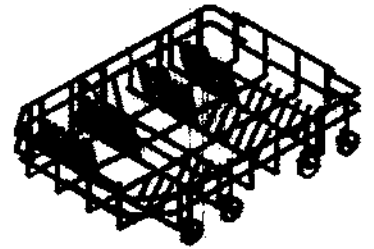

With fixed supports

To make full use of the space in the basket when large dishes are loaded, some models have tilting plate supports.

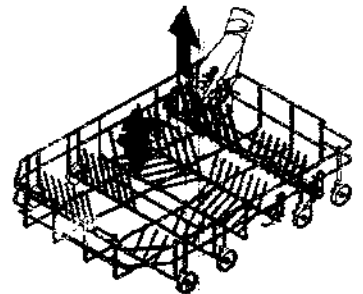

With tilting supports

##### LOADING THE LOWER BASKET

Carefully load flat plates, soup plates, dessert and serving dishes, positioning them vertically. Pots, pans and their covers must be loaded upside down. When loading soup plates and dessert bowls, be sure to leave a gap between them.

##### Loading examples:

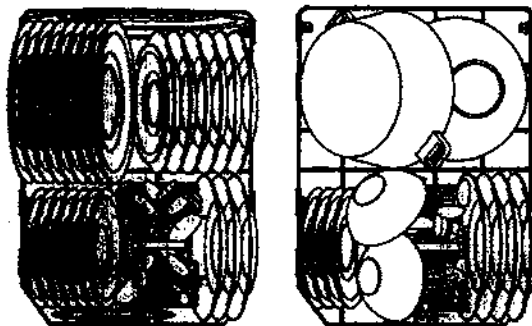



## CUTLERY BASKET

The cutlery should be arranged in an orderly manner inside the basket, with the handles pointing downwards. Take care during loading to avoid injury from the knife blades.

The basket is suitable for all types of cutlery, except those long enough to interfere with the upper spray arm.

Ladles, wooden spoons and cooking knives can be placed in the upper basket, making sure that the knife blades do not protrude from the basket.

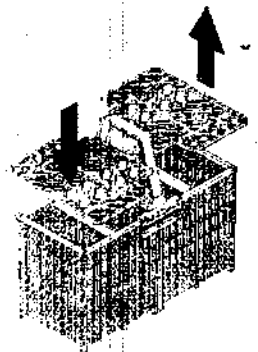

## UPPER BASKET

It is recommended to load the upper basket with small- or medium-sized items such as glasses, small plates, tea or coffee cups, shallow bowls and light objects made from heat resistant plastic. If the upper basket is used in the lowermost position, it can also be loaded with serving dishes, provided they are only slightly soiled.

To make the most of the space available, the basket has two lift-up plastic cup racks.

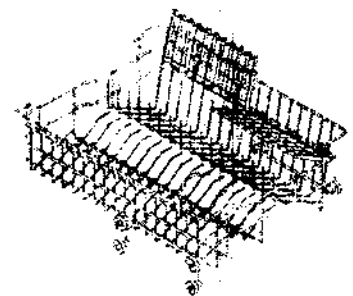



### LOADING THE UPPER BASKET

Load the dishes with the top side facing forwards; cups and concave containers should always be loaded with the opening facing down. The left side of the basket can be loaded with cups and glasses on two levels. On the right plates and saucers can be slotted vertically into the forks.

Loading examples:

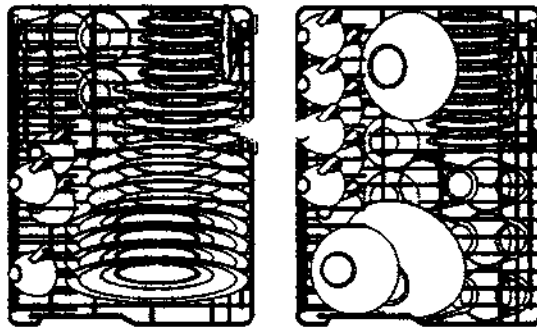

### ADJUSTING THE UPPER BASKET

The upper basket can be adjusted in **two positions**, according to the user's needs and according to the height of the dishes in the lower basket.

Proceed as follows:

- turn the retainer **E** on both runners, right and left, through **90°**;
- remove the basket;
- lift the basket and fit the smaller pairs of wheels in the runners;
- return the retainers **E** to their original position.

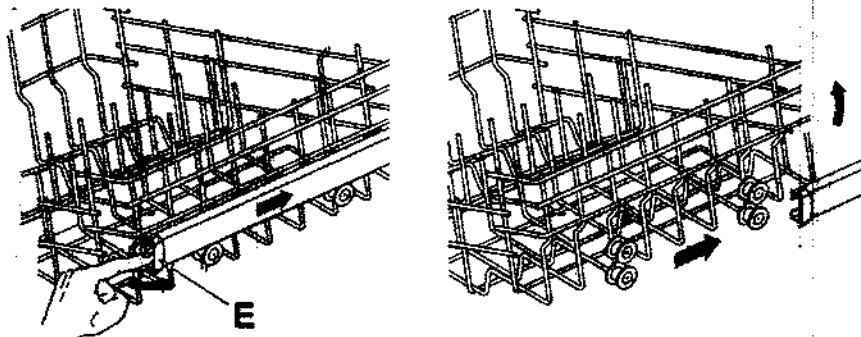



## 5. Cleaning and maintenance



**Before carrying out any work, always disconnect the appliance from the electrical power supply.**

### 5.1 General warnings and recommendations

**Avoid the use of acidic or abrasive detergents.**

Clean the outer surfaces and door-lining of the dishwasher regularly using a soft cloth moistened with water or with a normal detergent suitable for painted surfaces.

Clean the door gaskets with a damp sponge.

Periodically (once or twice a year) it is advisable to clean the tank and gaskets, using a soft cloth and water to remove any deposits.

#### CLEANING THE WATER INTAKE FILTER

The water intake filter **A** located at the outlet of the water supply tap needs to be cleaned periodically.

After having closed the water supply tap, unscrew the end of the water intake hose, remove the filter **A** and clean it delicately under running water. Reassemble filter **A** in its seat and carefully screw the water intake hose back into position.



#### CLEANING THE SPRAY ARMS

The spray arms can be easily removed for periodic cleaning of the nozzles, to prevent possible clogging. Wash them under running water and carefully replace them in their seats, **checking that their rotary movement is in no way impeded.**

- To remove the **upper** spray arm, unscrew locking ring **R**.
- To remove the **lower** spray arm, simply lift it up, pulling by the central part.

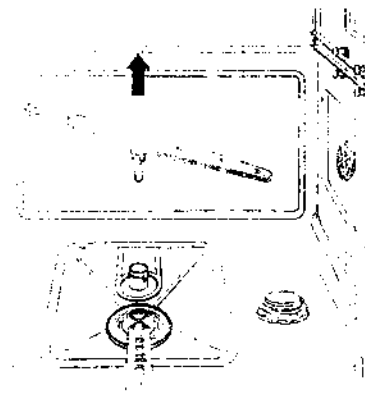
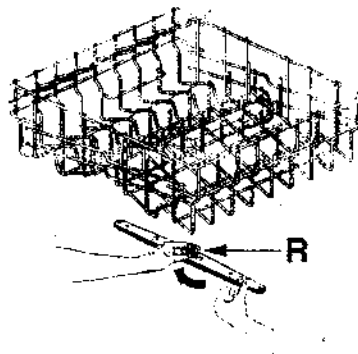



### CLEANING THE FILTER UNIT

- The filter **H** should be periodically removed and inspected, and if necessary, cleaned. To remove the filter, take hold of the handle and turn clockwise, then lift upwards.
- Then separate parts **L** and **M**, and separate the two parts of the plastic filter by pressing gently in the points shown, lifting it upwards to extract it.
- Remove the centre filter by lifting it upwards.

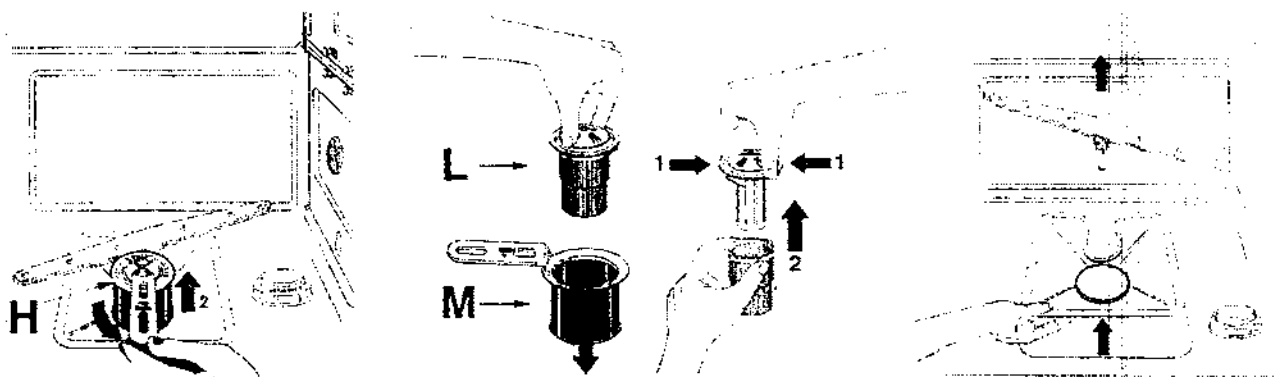

### GENERAL WARNINGS AND RECOMMENDATIONS FOR CORRECT MAINTENANCE:

- The filters should be cleaned under running water using a stiff brush.
- It is essential to **thoroughly clean the filters** according to the above instructions: the dishwasher cannot function if the filters are clogged.
- **Carefully replace the filters in their seats, to avoid damaging the wash pump.**

### PROLONGED DISUSE:

- Run the spak program twice in succession.
- **Unplug the power cord from the socket.**
- **Leave the door slightly open, in order to prevent the formation of unpleasant odours inside the washing tank.**
- **Fill the rinse aid dispenser.**
- **Shut off the water supply tap.**



## **BEFORE STARTING THE DISHWASHER AFTER PROLONGED DISUSE:**

- Check that there are no deposits of sludge or rust inside the water pipe: if there are, allow the water to run from the water supply tap for a few minutes.
- Plug the power cord back into the socket.
- Reconnect the water intake hose and open the tap again.

## **TROUBLESHOOTING MINOR PROBLEMS**

In some cases it is possible to remedy minor problems by referring to the following instructions:

### **If the program fails to start, check that:**

- the dishwasher is connected to the electrical power supply;
- there is no power failure;
- the water tap is open;
- the dishwasher door is properly closed.

### **If water remains inside the dishwasher, check that:**

- the drain hose is not kinked;
- the drain siphon is not obstructed;
- the dishwasher filters are not clogged.

### **If the dishes are not being cleaned properly, check that:**

- the correct amount of detergent has been added;
- there is regenerating salt inside the special container;
- the dishes are being loaded correctly;
- the selected program is suitable for the dish types and their degree of soiling;
- all the filters are clean and positioned correctly;
- the spray arm nozzles are not obstructed;
- there is no object obstructing the rotation of the spray arms.



**If the dishes fail to dry or remain dull, check that:**

- there is rinse aid inside the special container;
- the rinse aid dispenser setting is correct;
- the detergent used is of good quality and has not lost its effectiveness (for example, through incorrect storage, with the box left open).

**If the dishes show signs of streaking, staining, etc., check that:**

- the rinse aid dispenser setting is not too high.

**If there are visible traces of rust inside the tank:**

- the tank is made of steel, and therefore any rust marks are due to external elements (fragments of rust from the water pipes, pots, cutlery, etc.). Special products are commercially available to remove such marks;
- check that the amount of detergent being used is correct. Certain detergents can be more corrosive than others.
- check that the cap of the salt container is securely closed, and that the water softening setting is correct.



If after following the above troubleshooting instructions the problem persists, call the nearest After-Sales Centre.

**WARNING:** any operations performed on the appliance by unauthorised persons are not covered by the warranty and shall be paid for by the user.



## 6. Troubleshooting

The dishwasher is capable of signalling a number of faults through the simultaneous illumination of several indicator lights, with the following meanings:

FAULT					DESCRIPTION
E1					<p><b>The dishwasher's anti-flooding system has been activated (only for models equipped with the "TOTAL ACQUASTOP" device).</b></p> <p>This alarm is triggered in the event of a water leak in the dishwasher. In such circumstances the technical service centre must be called.</p>
E3					<p><b>The dishwasher fails to heat the water.</b></p> <p>Repeat the wash program. If the problem persists, contact the customer technical service centre.</p>
E4					<p><b>The temperature monitoring system has failed.</b></p> <p>Switch the dishwasher off, switch it back on and restart the washing program.</p> <p>If the alarm recurs, call the After Sales Service.</p>
E5					<p><b>The dishwasher fails to draw water.</b></p> <p>Ensure the plumbing connections are in order and that the water supply tap is open.</p>
E6					<p><b>The dishwasher fails to drain.</b></p> <p>Check that the drain hose is not kinked, the siphon is not obstructed and the filters are not clogged.</p>

Light off

Light on

Light flashing

If an alarm occurs the appliance interrupts the program in progress and signals a fault.

- In case of E1, E3 and E4, the washing program must be set again to continue.
- In case of E5 and E6, simply open and close the door to continue (once the cause of the fault has been illuminated).

**TECHNICAL DATA**

<b>Width</b>	447 ÷ 449 mm
<b>Depth measured flush with the outer edge of the control panel</b>	570 mm
<b>Height</b>	from 820 mm to 870 mm
<b>Capacity</b>	9 Standard place settings
<b>Water supply pressure</b>	min. 50 – max. 900 KPa (min. 0.5 – max. 9 bar)
<b>Electrical characteristics</b>	See rating plate