



# C2100

**Caple Touch Control single Oven  
Stainless Steel**



**INSTRUCTION MANUAL**

## INDEX

### OVEN PRESENTATION

Installation and Connection	25
Demo mode	27
Regulating the clock	28
Switching on the oven	29

### Main Functions

View of front console	30
Cooking functions	30
Simple gestures for cooking	31
Regulating the cooking temperature	32
Residual heat	32
The food probe	33
Special functions: turbo heat and turbo clean	37
Oven light control	38

### Programming the oven

Programming the timer: cooking time	39
Programming the timer: cooking end time	40
Programming the timer: delayed cooking	41
Programming the timer: minute counter	42
Programming the timer: cancelling the programme	43

### Safety

Over lock function	43
--------------------	----



## OVEN PRESENTATION

Dear Customer, your new oven is managed by an electronic card which constantly monitors its operation in order to improve its all-round performance.

The state-of-the-art, reliable and precise touch control system.  
The elegant, orderly and discreet interface, more user-friendly than ever before!

Just a few buttons, lots of functions and no difficult combination or sequence of buttons. Simply concentrate on following the recipe and the oven is ready with two movements!!!

English

## Installation and Connection

Dear Customer, this oven is a sophisticated electrical appliance, classified as a durable item. It must be installed by qualified personnel who operate in compliance with the very highest standards both for connection to the electricity supply and installation into the kitchen unit.

series 45

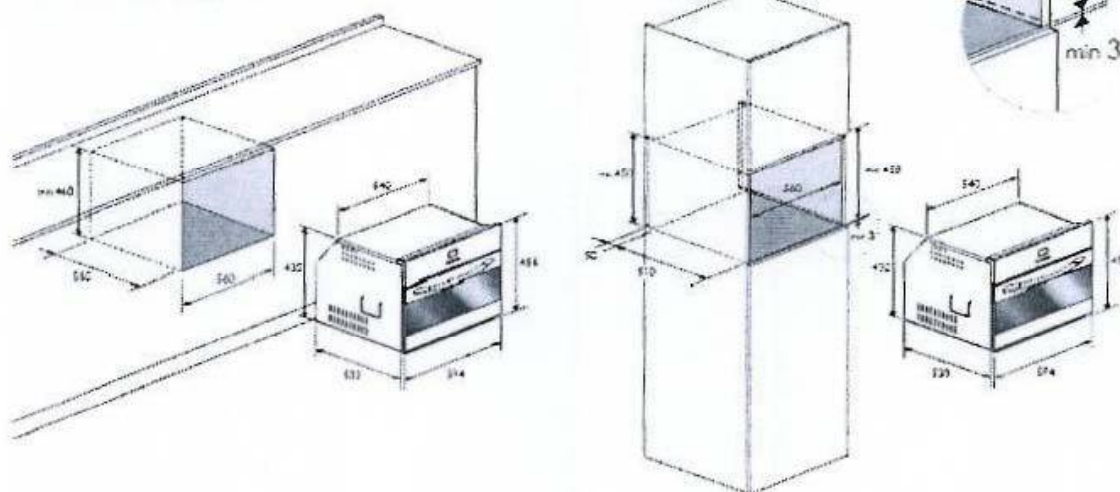

series 72

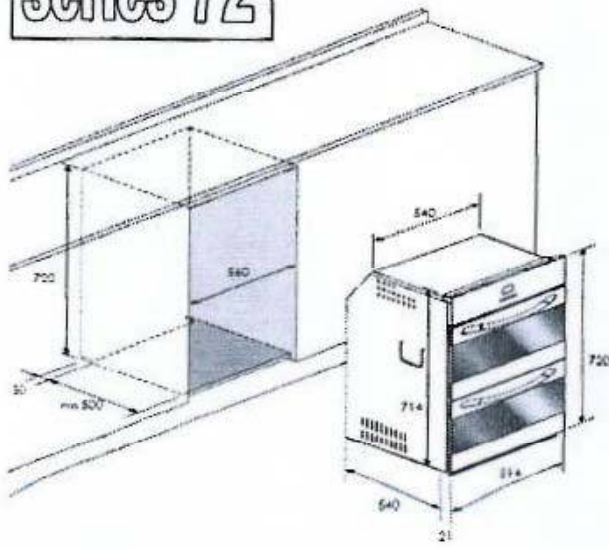

series 88



English

Demo mode



## Regulating the clock

English

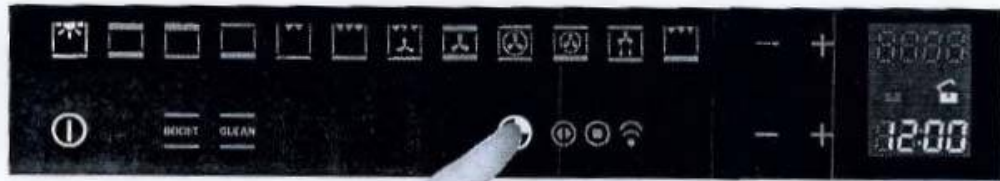

The oven signals the connection to the electricity main with a double beep.  
To regulate the system time, press the TIMER FUNCTIONS button for 5 sec.



Every control used is confirmed by a beep.



Regulate the clock using the + and - buttons:  
the dividing dots flash while the time is being set and  
stop flashing when the time has been acquired.

## Switching on the oven



The oven is switched on using the ON/OFF symbol shown in the figure.  
The control activates all the symbols, illuminating the background.

English



The control will wait eight seconds after switch-on for a cooking function to be chosen. Otherwise it interprets the switch-on as accidental and automatically switches off the oven for safety reasons.

## MAIN FUNCTIONS

### View of front console

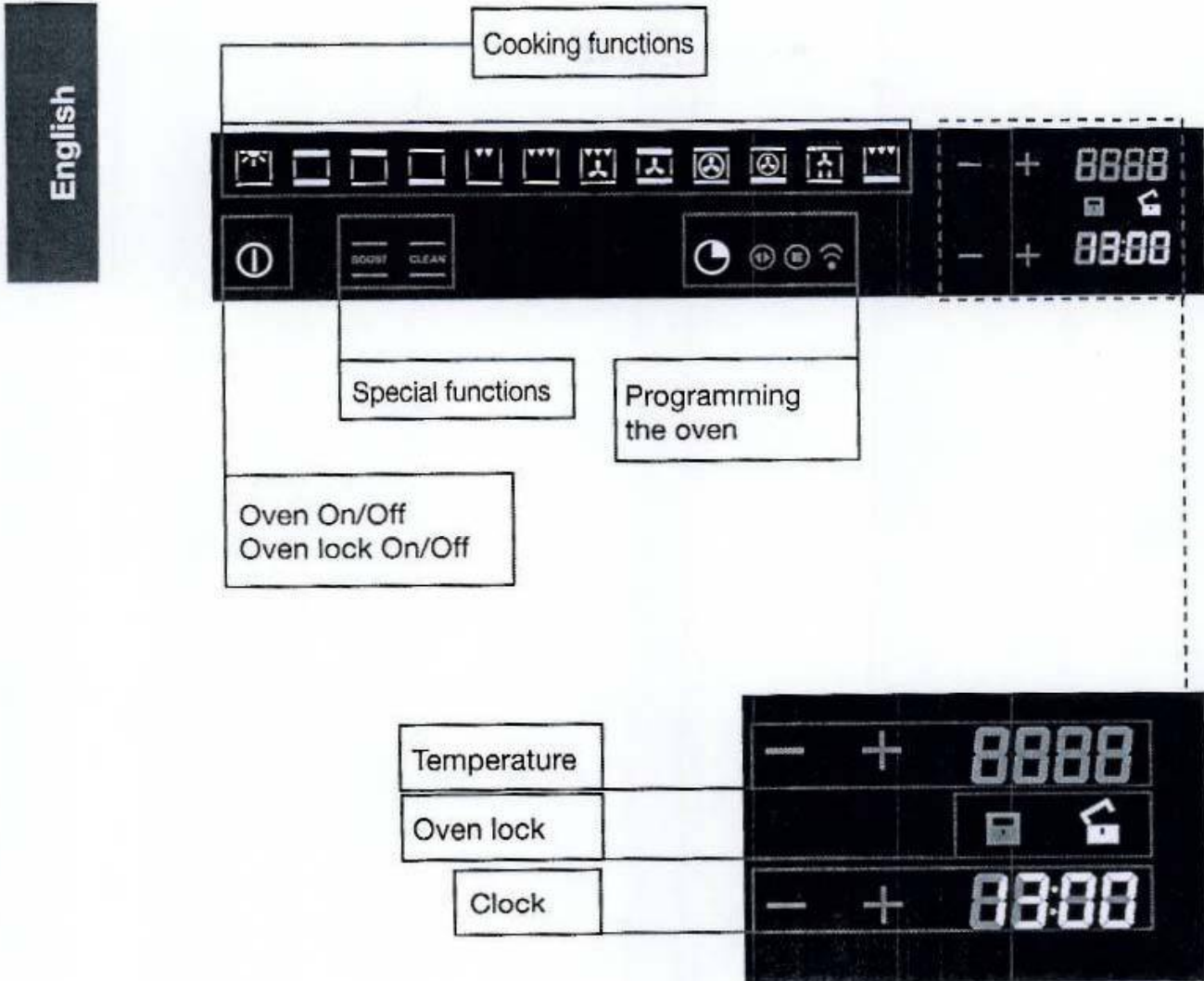

### Cooking functions

The control makes a total of twelve specific cooking functions available!

Every function has a set temperature chosen on the basis of cooking tests using frequently used recipes and can easily be adjusted to suit personal preference.

The following table contains the results of the cooking tests carried out in our laboratories by a professional chef. However, this is merely a guide and the values indicated are simply to help you get started and try our your own recipes, always achieving the best results!

F								
°C	160-200	160-180	140-160	200-230	210-220	160-180	190	230-250
	2-3	2	2	1-3	2	2-3	2-3	4-5
	30'- 50'	20'- 40'	10'- 40'	10'- 20'	45'- 60'	45'- 60'	60'- 70'	14'-18'

F									
°C	225-250	160-180	210-230	160-190	200-220	160-180	175-190	190-210	170-190
	2	2	2	2	2-3	2	2	2	3
	120'- 150'	120'- 160'	90'- 120'	90'- 120'	50'- 60'	45'- 60'	60'- 70'	40'- 50'	40'- 50'

### Simple gestures for cooking

Two simple movements are all it takes to set a cooking programme, thanks to the state-of-the-art control logic: switch on the oven and select the best function for the dish you are preparing. Simply select it and touch it!

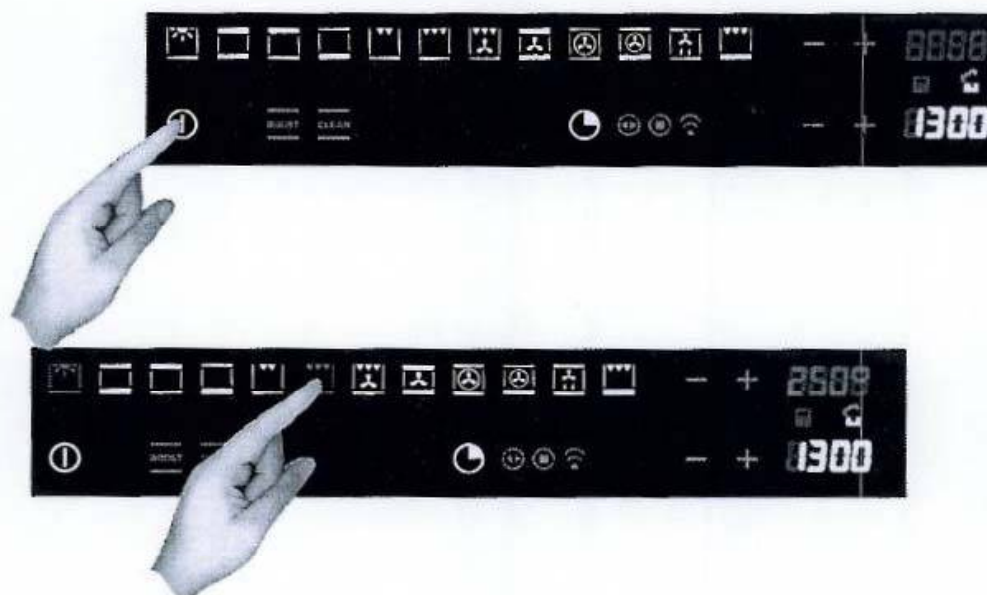

The control proposes a temperature for every function. It is possible to change it any time, but if you are happy with it, you don't need to do anything else. The oven will be automatically activated in a few seconds!

## Temperature Regulation

The control makes use of a temperature probe with a level of precision of  $\pm 5^{\circ}\text{C}$  offering maximum reliability of the cooking times required.

To change the temperature simply use the plus and minus symbols. The range of regulation varies from  $+50^{\circ}\text{C}$  to  $+250^{\circ}\text{C}$ .

It isn't necessary to confirm the change, as the control is automatically activated after just a few seconds.

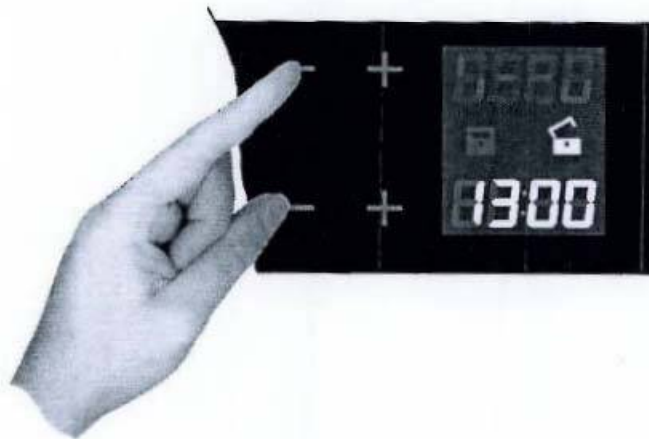

During the heating process, the degrees centigrade symbol ( $^{\circ}\text{C}$ ) symbol flashes, indicating that the heat is being regulating to reach the temperature required. When the correct temperature is reached, you will hear a beep.

## Residual heat

While cooking food, the structure of the oven stores heat. This heat is kept isolated from the rest of the kitchen thanks to an excellent insulation system and certain construction details.

The heat is gradually dispersed can be used as a further cooking resource if managed appropriately: the control indicates the interior temperature, after the oven has been switched off, until it reaches  $50^{\circ}\text{C}$ .



use this feature to keep food warm or to gently complete the cooking process.

## Food probe (or probe thermometer) (available on certain models)

The food probe is a thermometer which, when inserted into the food, makes it possible to check the internal temperature and use it to establish the end of cooking. For example, meat may look like it is cooked on the outside, but still be pink on the inside!



The temperature reached by food during cooking is closely linked to problems relating to health and hygiene. Bacteria can be contained in every kind of meat, poultry and fish, as well as raw eggs.

Certain types of bacteria make food go off, while others, such as Salmonella, Campylobacter jejuni, Listeria monocytogenes, Escherichia coli and Staphylococcus aureus can be seriously harmful to human health.

Bacteria multiply very quickly above a temperature of 4.4° up to 60°C. Mince is particularly at risk from this point of view.

To prevent bacteria from multiplying, it is necessary to take the following measures:

- Do not defrost food at room temperature, always in the fridge or in the oven using the specific function. In the latter case, cook the food immediately afterwards.
- Stuff chicken just before eating it. Never buy pre-packed ready-stuffed chicken and only buy ready-cooked stuffed chicken when you intend to eat it within 2 hours.
- Marinate food in the fridge, not at room temperature.
- Use a food probe to check the temperature of meat, fish and poultry if they are more than 5 cm thick, to ensure that the minimum cooking temperatures are reached. The greatest hazards are posed by poorly cooked chicken, particularly at risk from Salmonella.
- Avoid interrupting the cooking process, i.e., partially cooking food, storing it and completing the cooking process later. This sequence encourages the growth of bacteria due to the "warm" temperatures reached inside the food.
- Roast meat and poultry in the oven at temperatures of at least 165°C.

## Using the food probe

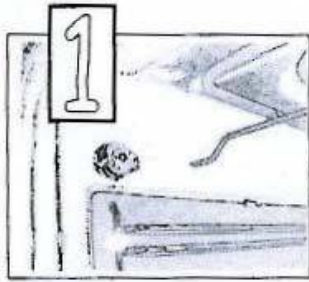

The food probe socket is situated in the top front corner of the oven cavity, protected by a metal cover.

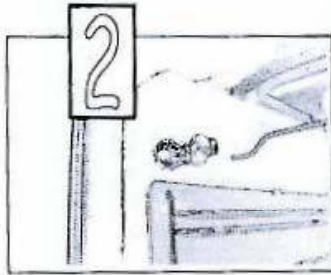

Push the plug in as far as it will go. If it is correctly inserted, the control will give off a double beep.

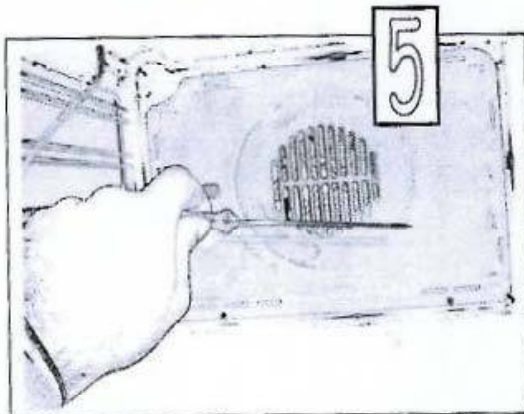
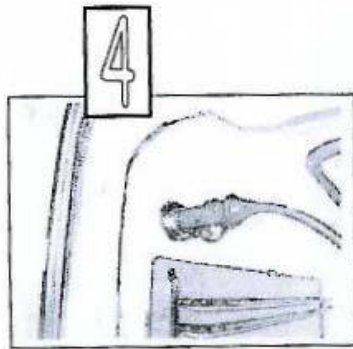
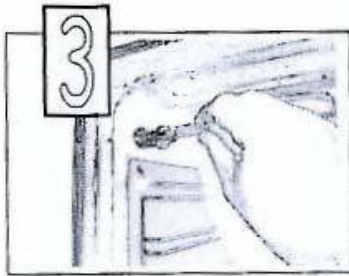

Push the probe into the centre of the food, avoiding touching bones or fatty areas.



Remember that the probe will not work if it is connected when the oven is already switched on!

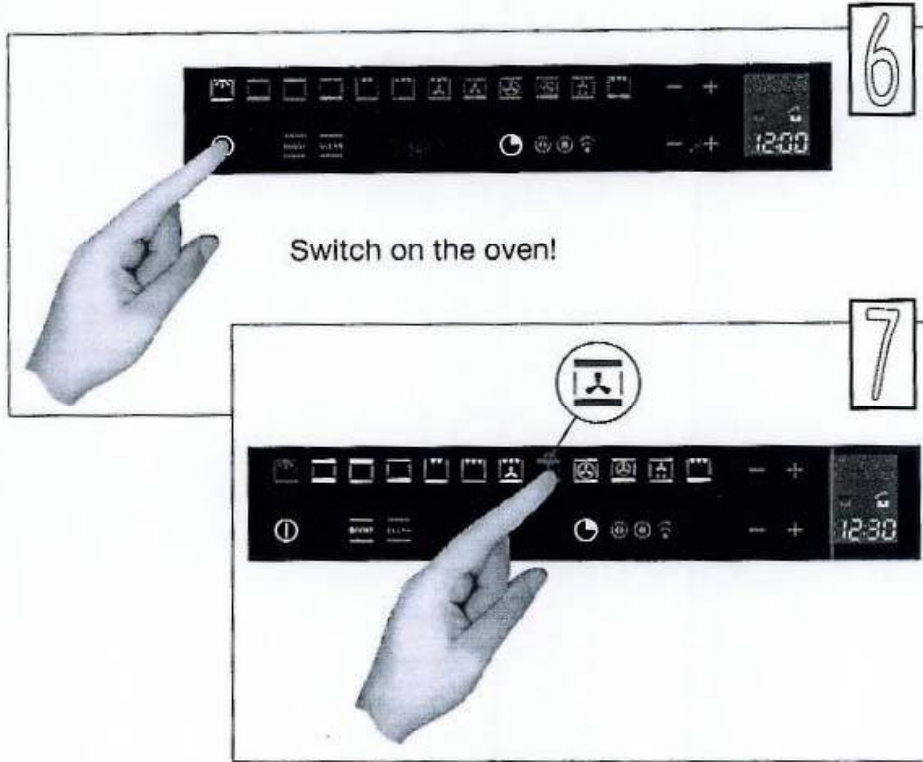

English

Select the best cooking function for your recipe.

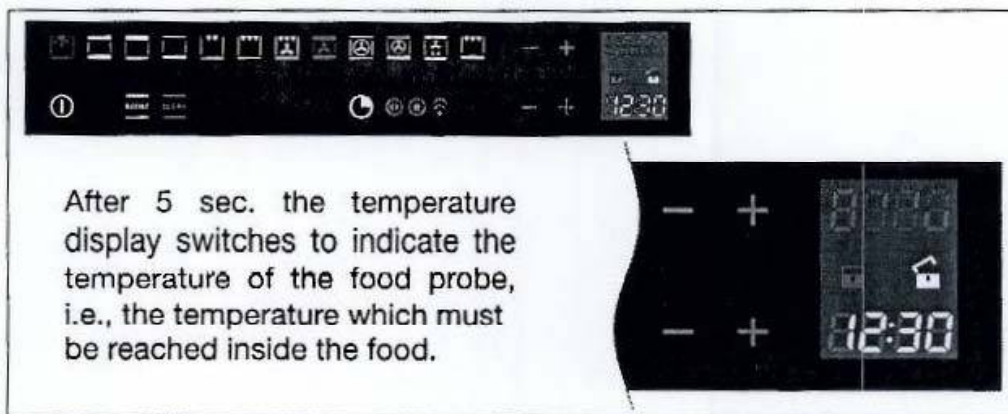

You can change the minimum internal temperature value to suit requirements within an interval of +30°C to +99°C, but we recommend that you consult the table below, taken from THE NATIONAL FOOD SAFETY DATABASE (USA)

FOOD	MINIMUM INTERNAL TEMPERATURE
<b>Mince</b>	
Hamburger	71°C
Beef, veal, lamb, pork	74°C
Chicken, turkey	74°C
<b>Beef, veal, lamb</b>	
<i>Roasts and steaks:</i>	
Rare	The cooking temperature for rare meat is not indicated by the NFSD as it is unsafe for health reasons
Medium-rare	63°C
Medium	71°C
Well done	77°C
<b>Pork</b>	
<i>Chops, roasts, ribs:</i>	
Medium	71°C
Well done	77°C
Fresh ham	71°C
Fresh sausages	71°C
<b>Poultry</b>	
Whole chicken or chicken pieces	82°C
Duck	82°C
Whole turkey (not stuffed)	82°C
Turkey breast	77°C



If the plug is removed after cooking begins, the control blocks the oven and signals the error by beeping: plug the probe in again to resume cooking!



When cooking with the aid of the food probe, all the pre-set temperatures are changed, to maintain consistency with the philosophy of use, to 165°C: they can be varied from a minimum of 120°C to a maximum of 250°C. For the same reason, the defrosting function is deactivated.



The end of cooking, established by reaching the internal temperature set for the food probe. All the oven programming functions (timer functions) are stopped, apart from the beeper (minute counter).

When the food probe senses the temperature for which it has been set, the oven is automatically deactivated and you will hear a beep!

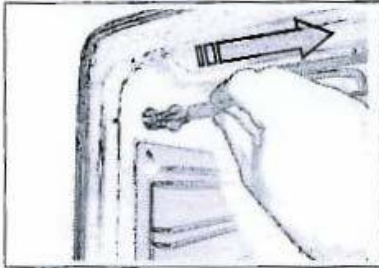

When the cooking time is up, remember to disconnect the food probe and remove it from the oven.

**CAUTION: the probe is very hot after cooking.**

If the probe is left connected to the oven but not inside the food, an error may be generated (ERR3) on the timer display. The error will disappear when the probe is disconnected from the oven.

## SPECIAL FUNCTIONS

### Boost (quick preheat)

This special function can be activated after selecting a cooking function and is used to reduce the time required to reach the set cooking temperature.

This period of time is known as preheating, and is required in practically all recipes.

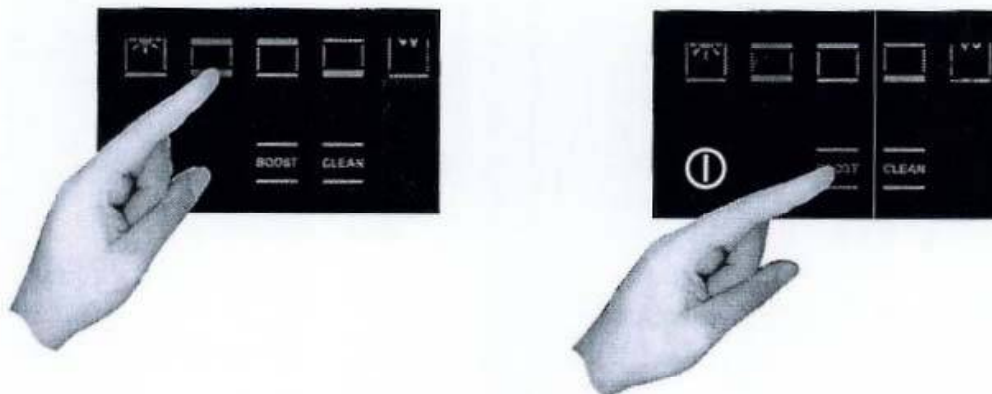

It is possible to disconnect the turbo heat function or change cooking function at any time.

### Clean (quick cleaning)

Correct operation is combined with the use of the lateral panels and catalytic fan cover: the oven is treated with special enamel with a micro-porous structure, which breaks down the fat projected thanks to a catalytic oxidation process which transforms residues into gaseous products.

The turbo clean function is only activated when no cooking function has been selected, so: switch on the oven and touch the symbol as shown in the figure for five seconds.

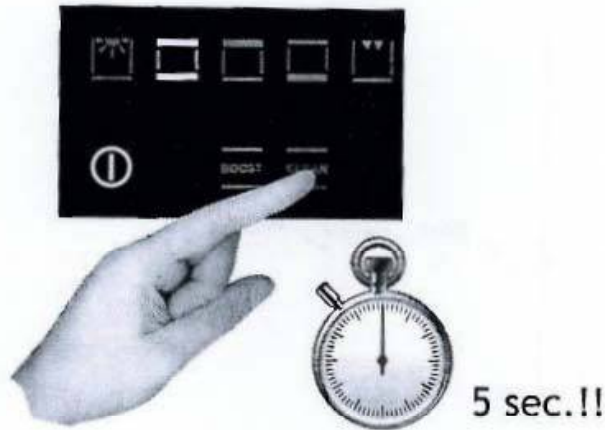

The cleaning process takes place at a temperature of 250°C and lasts one hour. Do not use it for cooking food!!

The oven light is activated and can be switched off and on again at any time.

All the self-cleaning panels will perform effectively for thirty cleaning processes, after this limit the panels must be replaced.

The panels should be cleaned exclusively with tap water and replacements can be ordered from your specialised dealer.

### Oven light control

The light control is active on all the cooking functions and is independent, meaning that it can be switched on or off to suit your requirements, when you want!

The oven light is usually kept on throughout the heating time and then for three minutes after reaching the temperature set. From then on, the oven light switches off to save power.

To check the cooking, it may be necessary to switch on the internal light. All you have to do is touch the light symbol: the light will stay on for three minutes and then switch off automatically. Naturally you can switch it off immediately by touching the light symbol again.

Some models are equipped with a door control. This feature uses sensor technology to detect the position of the door to control the oven light: the opening of the door is indicated by a beep and the light comes on. It switches off when the door is closed again.

## PROGRAMMING THE OVEN

The programming of the oven offers three modes for controlling the cooking time. They are available with the standard cooking functions. When the food probe is used, they are deactivated (see specific chapter).

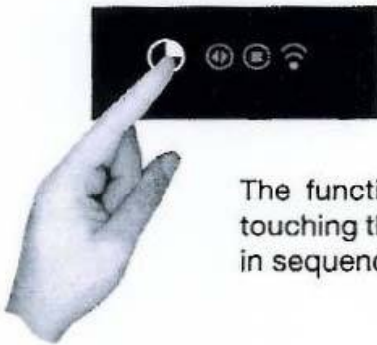

The functions can be selected in sequence, from left to right, by touching the clock symbol: every time it is touched, a symbol lights up in sequence.

English

### Programming the timer: cooking time

Touch the timer symbol once. The relative symbol lights up. The clock display will replace the indication of the current time:

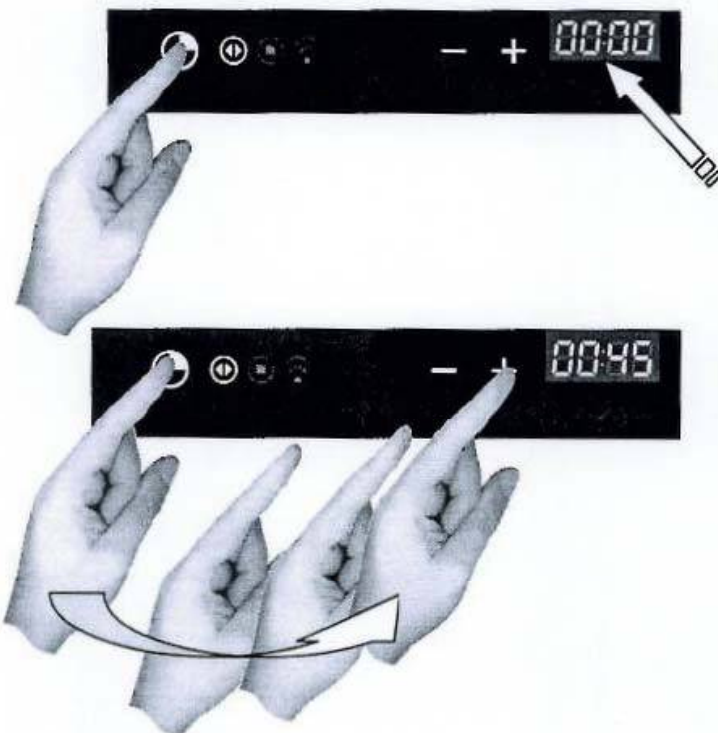

The dividing dots flash to indicate that it is possible to programme the cooking time



Once the cooking time has been set, the display will show the current time again and the cooking time symbol will be lit.

The count begins now. When the time is up, the oven will make a beeping sound, the heating elements will be switched off and cooking will stop. The special symbol will flash, as will the duration which was set on the clock display. Press any button to stop the beeping sound.

After eight seconds, the oven switches off automatically unless other cooking functions are programmed.

### Programming the timer: cooking end time

Touch the timer symbol twice. The relative symbol lights up.

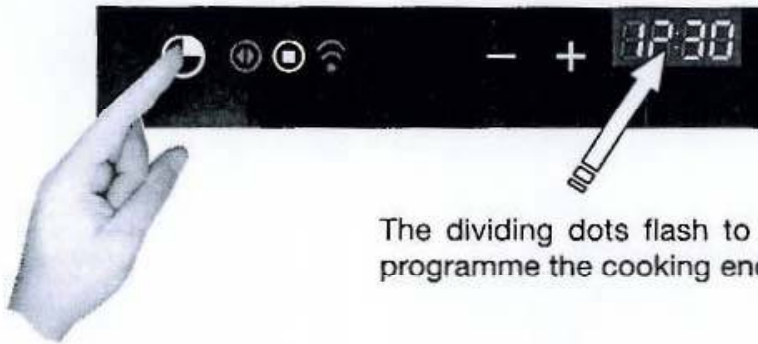

The dividing dots flash to indicate that it is possible to programme the cooking end time.

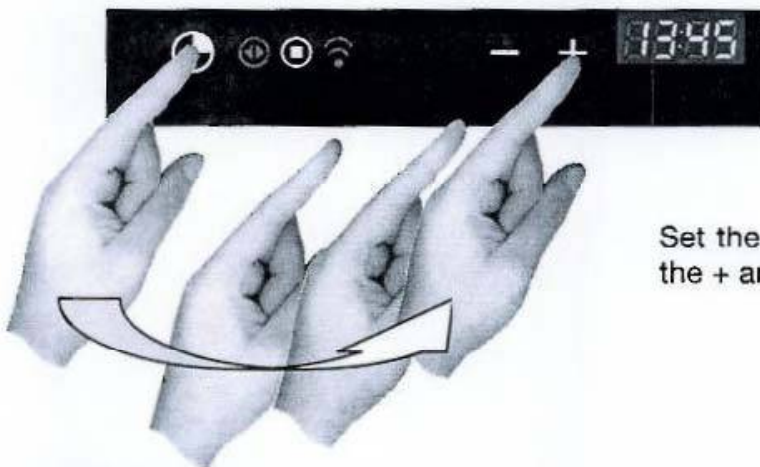

Set the cooking end time by touching the + and - symbols.



Once the cooking end time has been set, the display will show the current time again and the cooking end symbol will be lit.

The count begins now. When the set time is reached, the oven will give off a beep, the heating elements will be switched off and cooking will stop. The special symbol will flash, as will the cooking end time which was set on the clock display: press any button to stop the beeping sound.

After eight seconds, the oven switches off automatically unless other cooking functions are programmed.

### Programming the timer: delayed cooking

Using the combination of the two cooking time and cooking end time modes, it is possible to programme the oven to start cooking at a later time than the current time.

For example, it is 8.30 a.m. and you're about to leave home, but you would like a roast to be ready for 1.00 p.m.. Here's what to do:



Prepare the roast for cooking and place it in the oven.

Switch on the oven, select the cooking function and set the temperature.

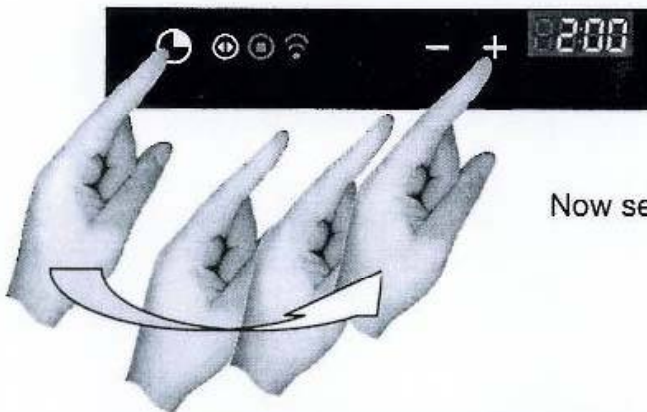

Now set the cooking time, let's say two hours.

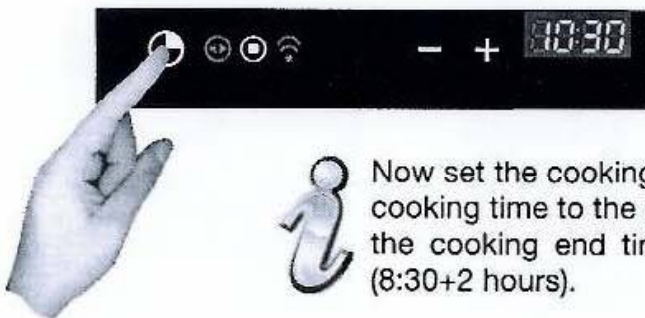

Now set the cooking end time: the control usually adds the cooking time to the current time and proposes the result as the cooking end time. In our case it will propose 10:30 (8:30+2 hours).



Change the cooking end time to make it coincide with the time you require. In our example this is 1.00 p.m.

The oven now enters into stand-by and the oven light switches off. When it is time to start cooking, the light will not be automatically switched on because it is logical to assume that the delayed start coincides with your absence, so it is pointless to leave the light on for no reason.



The control will automatically activate the oven at 11:00 (1:00 p.m. -2 hours) and will switch it off at 1.00 p.m., meaning that the roast will be ready when you arrive home!

### Programming the timer: minute counter

The minute counter is a function of the timer which is independent of the operation of the oven, meaning that it does not block the cooking and does not switch off the oven, but acts as a beeper. You can set it at any time, as a reminder to check cooking on the hob, as well as the oven, or for other cooking activities.

This can also be used with the oven switched off. In this case all you have to do is touch the timer function symbol.

If you use it with the oven switched on, you must touch the time function symbol three times in a row.



The dividing dots flash to indicate that it is possible to set the value.



Set the minutes using the + and - symbols.

The count begins now. When the time indicated is up, the oven will make a beeping sound and the special symbol will flash. Press any button to interrupt the beeping sound.

### Programming the timer: cancelling the programme

To cancel a programme, it is necessary to take the value assigned previously to zero or switch off the oven.

### SAFETY: OVEN SWITCH-ON LOCK

The control makes a lock available on the console to prevent the oven from being switched on or the cooking settings from being interfered with. It can be activated and deactivated at any time using the on/off button.

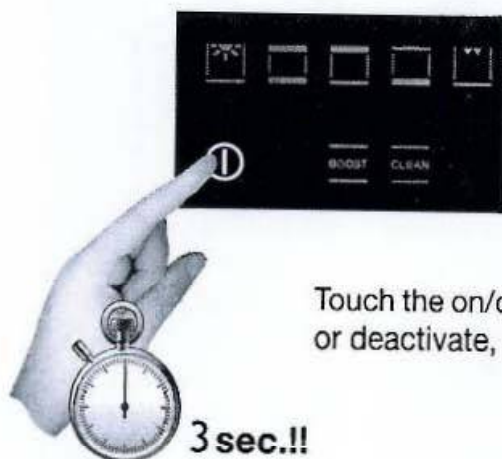

Touch the on/off symbol for at least three seconds to activate or deactivate, alternately, the oven lock.

3 sec.!!



Lock activated:  
red padlock closed symbol on the display Every action linked to cooking is disabled.

English



Lock deactivated:  
white padlock open symbol on the display