

# Ceramic Touch Control Hob

LAM1745



User Guide

---

# LAMONA

Exclusive to Howdens Joinery Co.

**Register**  
**my appliance**

[www.howdens.com/appliance-registration](http://www.howdens.com/appliance-registration)

Part No: 0835503001

Date: 09/02/2017

# Register my appliance

Register your Lamona appliance purchased from Howdens Joinery to allow us to easily contact you in the event of important product updates at:

[www.howdens.com/appliance-registration](http://www.howdens.com/appliance-registration)

## LAMONA

Exclusive to Howdens Joinery Co.

# INTRODUCTION

---

Thank you for buying this British-built appliance from us.

This user guide book is designed to help you through each step of owning your new product.

Please read it carefully before you start using your appliance, as we have endeavored to answer as many questions as possible, and provide you with as much support as we can.

General information, spares and service information is available from our website.

If you should find something missing from your product or have any questions that are not covered in this user guide, please contact us (see contact information inside the front cover).

## European Directives

As a producer and a supplier of cooking appliances we are committed to the protection of the environment and are in compliance with the WEEE directive. All our electric products are labelled accordingly with the crossed out wheeled bin symbol. This indicates, for disposal purposes at end of life, that these products must be taken to a recognized collection points, such as local authority sites/local recycling centres.



This appliance Complies with European Community Directives (CE) for household and similar electrical appliances and Gas appliances where applicable.

This appliance conforms to European Directive regarding Eco design requirements for energy-related products. Our policy is one of constant development and improvement, therefore we cannot guarantee the strict accuracy of all of our illustrations and specifications - changes may have been made subsequent to publishing.

## Disposal of Packaging Material

The packaging materials used with this appliance can be recycled. Please dispose of the packaging materials in the appropriate container at your local waste disposal facilities.

### **UK ONLY GAS WARNING:**

If you smell gas, Do not try to light any appliance. Do not touch any electrical switch.  
Call the Gas Emergency Help line at **0800 111999**

# SAFETY

---

## WARNING

- If the hob surface is cracked, broken or shattered, switch off the appliance to avoid the possibility of electric shock and call for a service engineer's visit.
- The appliance and its accessible parts become hot during use. Care should be taken to avoid touching heating elements. Children less than 8 years of age shall be kept away unless continuously supervised. This appliance can be used by children aged from 8 years and above and persons with reduced physical sensory or mental capabilities or lack of experience and knowledge if they have been given supervision or instruction concerning the use of the appliance in a safe way and understand the hazards involved. Children shall not play with the appliance. Cleaning and user maintenance shall not be made by children without supervision.
- Do not use a steam cleaner on any cooking range, hobs and oven appliances.
- The appliance is not intended to be operated by means of an external timer or separate control system.
- Unattended cooking on a hob with fat or oil can be dangerous and may result in fire.
- NEVER try to extinguish a fire with water, but switch off the appliance and then cover the flame with a lid or damp cloth.
- Danger of fire: Do not store items on the cooking surfaces.
- Only use hob guards designed by the manufacturer of the cooking appliance or indicated by the manufacturer of the appliance in the instructions for use as suitable or hob guards incorporated in the appliance. The use of inappropriate hob guards can cause accidents.

## CAUTION

- The cooking process has to be supervised. A short term cooking process has to be supervised continuously.
- **Fire Safety Advice**

If you do have a fire in the kitchen, don't take any risks - get everyone out of your home and call the Fire Brigade.

**If you have an electrical fire in the kitchen:**

- Pull the plug out, or switch off the power at the fuse box - this may be enough to stop the fire immediately
- Smother the fire with a fire blanket, or use a dry powder or carbon dioxide extinguisher
- Remember: never use water on an electrical or cooking oil fire.
  
- **Other Safety Advice**
- Servicing should be carried out only by authorised personnel.
- There is a risk of electric shock, so always make sure you have turned off and unplugged your appliance before starting. Always allow the product to cool down before you change a bulb.
- This appliance must be earthed.
- The appliance must never be disconnected from the mains supply during use, as this will seriously affect the safety and performance, particularly in relation to surface temperatures becoming hot and gas operated parts not working efficiently.
- **GAS WARNING!** - If you smell gas: Do not try to light any appliance, Do not touch any electrical switch. Contact your local gas supplier immediately.

# USING YOUR APPLIANCE

## Getting to know your product

**Note:** Your appliance layout may differ depending on the model.

### Hob

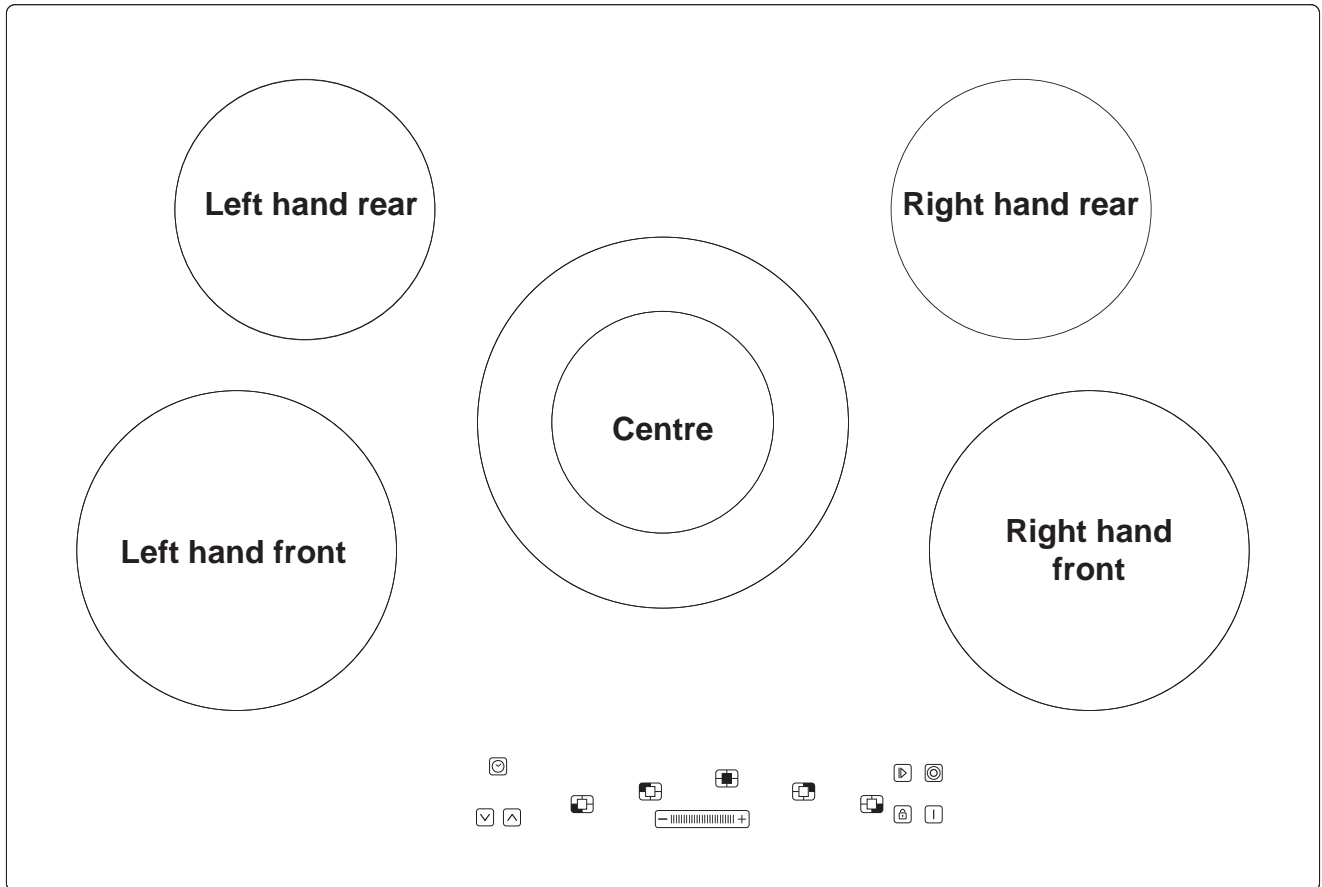

### Hob controls

Timer symbol



Timer adjust keys

Cook zone



Dual zone



Power level adjust slider

Pause key



Dual Zone key







Key lock



On/Off key

# Overview

Function	Description	Symbol
Power Level	Once a cook zone is selected, a power level can be set to a low or high temperature.	1-9
Residual Heat	After use, the cooking surface remains hot and the residual heat symbol will be displayed. As it cools, the residual heat symbol will disappear from the display.	
Key Lock	To avoid unintentional switching on of the appliance	
Pause	When the pause key is pressed, the LED flashes and a sound is heard. The pause function allows temporary pausing of the cooking process.	
Timer	All cooking zones can be operated under the timer independently and at the same time for up to 99 minutes. When the set time expires the timer will beep and the cook zone will switch off automatically.	

Always ensure the touch control area is clean, dry and free from any objects. A beeping sound will be activated and will keep on beeping every 10 seconds, to attract your attention. Please remove any objects and clean the area as appropriate.

**Note:** During cooking, the elements will cycle on and off. This is normal.

Failure to observe the above will result in the hob not functioning correctly, (Display showing “FL”). To rectify remove all strong lighting sources and re-apply power.

## **Switching the hob On/Off**

Press the On/Off key to activate or deactivate the appliance.

## **Key lock**

**1** Press and hold key lock

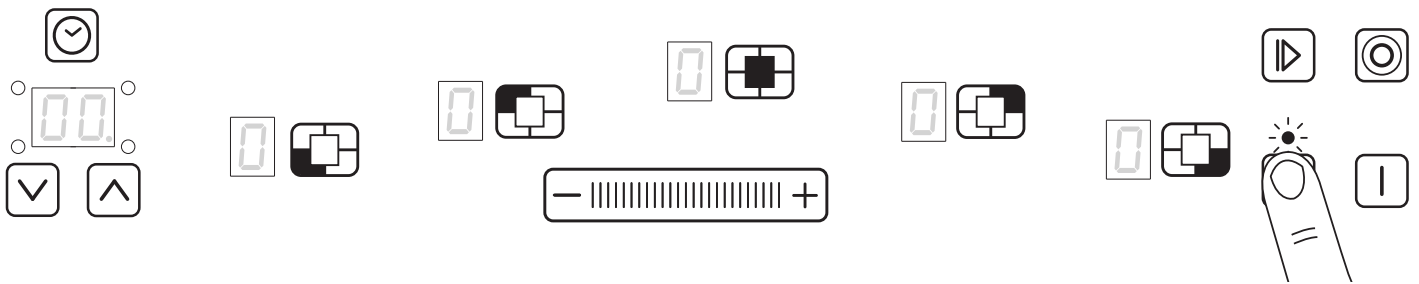

A Red Led indicates when the key lock is active. The key lock is deactivated when the Red LED switches off.

If any of the cook zones are on, the key lock function locks all the keys except the On/Off key. If the cook zones are off, the key lock function locks all the keys, including the On/Off key.

To avoid unintentional switching on of the appliance, e.g. by small children and pets, we recommend activation of the key lock feature.

## **Switching on an individual cook zone**

**1** Press and hold key lock to deactivate (if active)

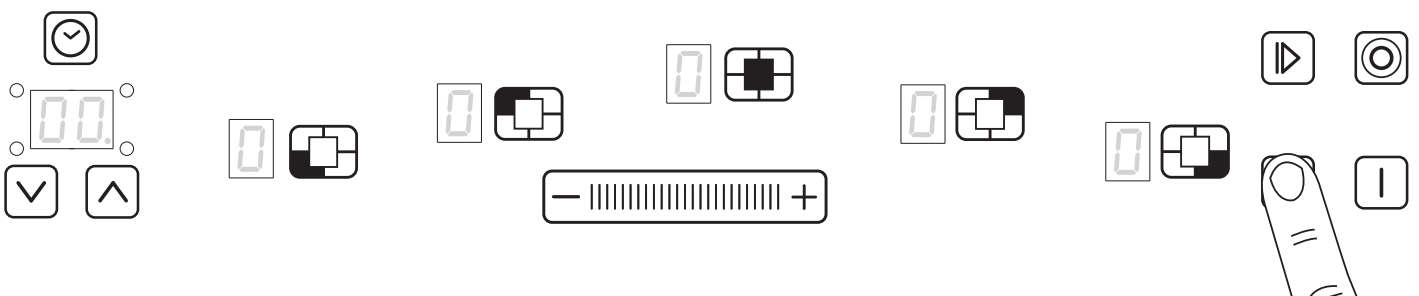

**2** Press and hold the On/Off key

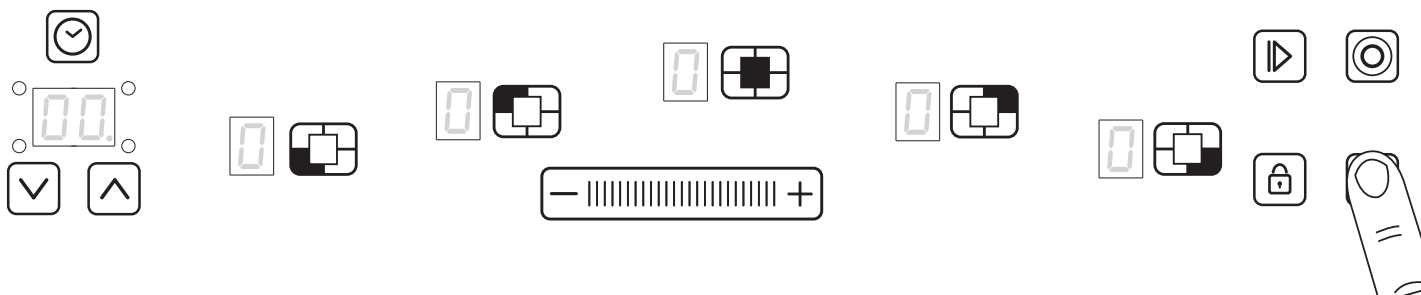

**3** Press the required cook zone key

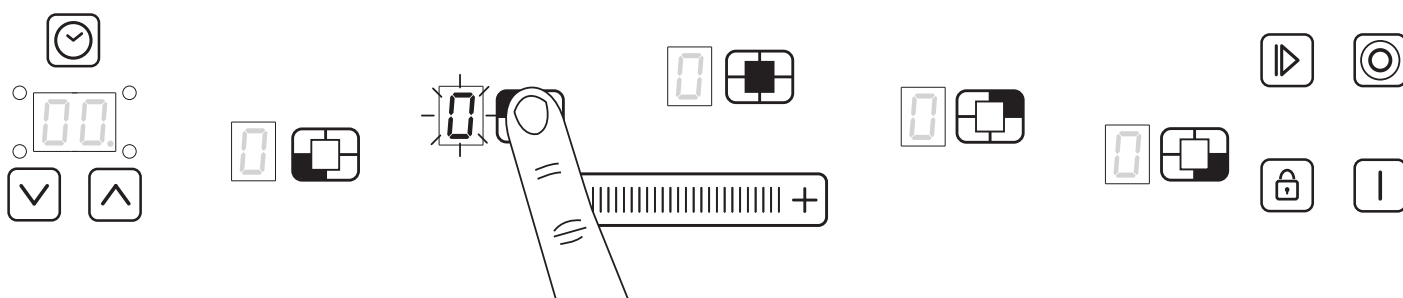

**4** Use the slider to adjust power level

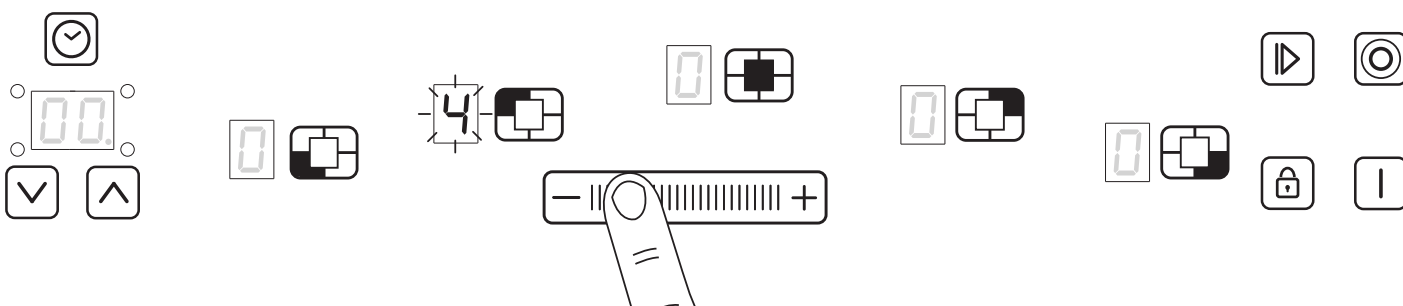

When a power level has been set, either touch the cook zone key again to confirm the setting or after 5-10 seconds, the hob will automatically set the hob power and will beep and stop flashing.

### **Switching off an individual cook zone**

**1** Press required cook zone key

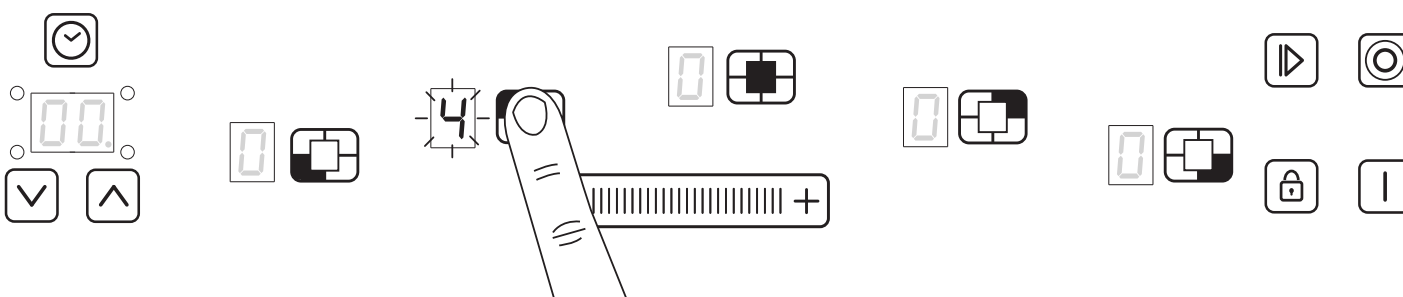

**2** Use the slider to select power level 0

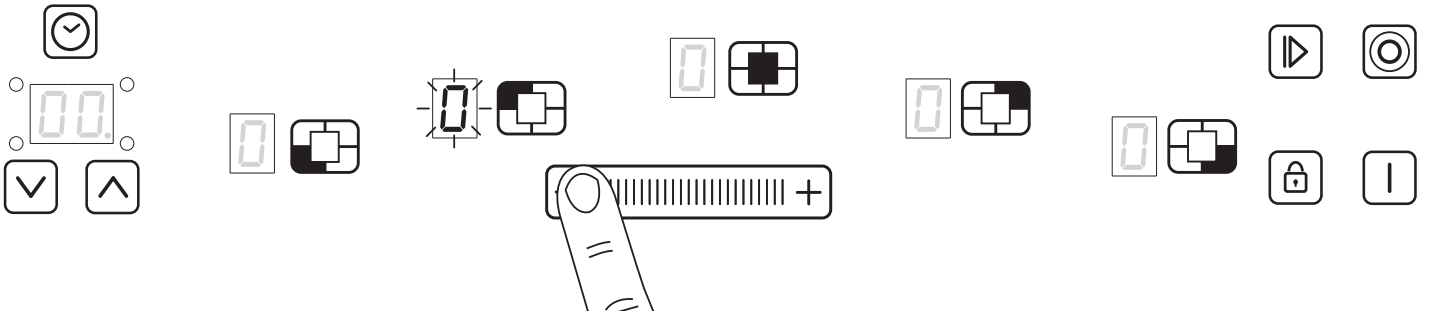

### Dual Zone (If fitted)

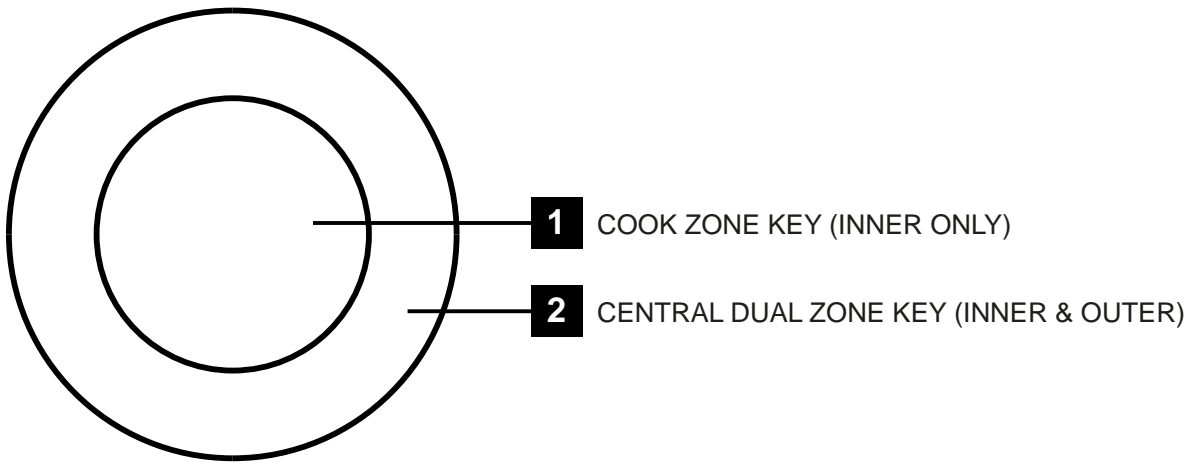

**Note;** Generic illustration shown above your appliance may visually differ.

### To operate the dual cook zone

**1** Select cook zone

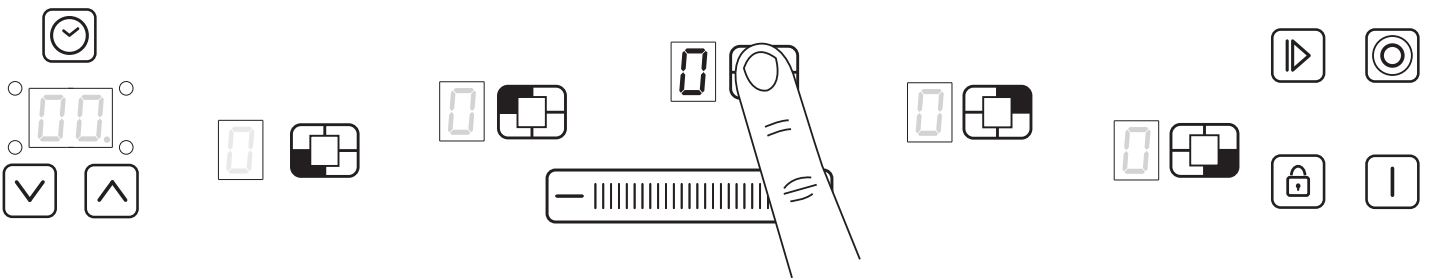

**2** Select power level

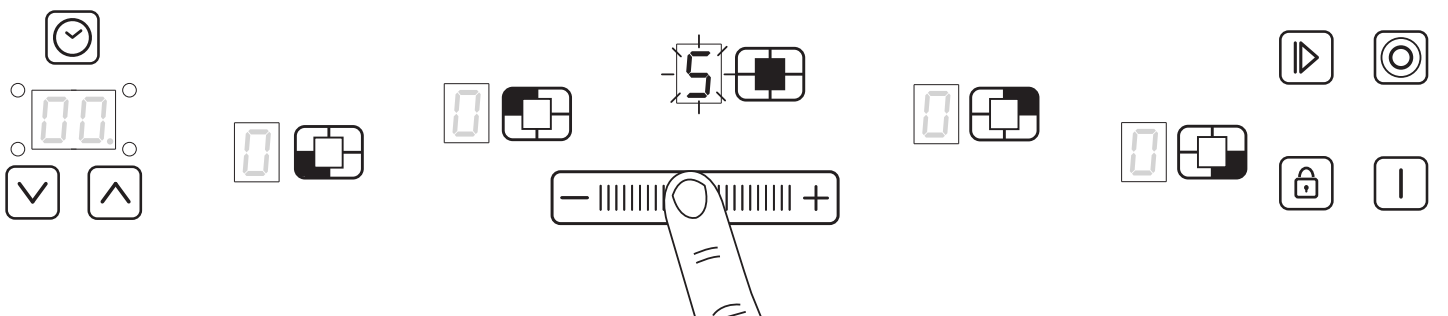

### 3 Press Dual Zone key

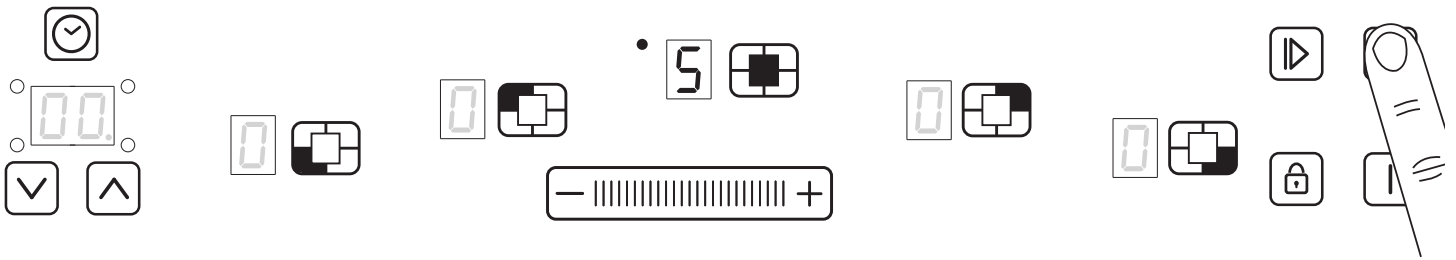

The power level of the cook zone will stop flashing and the power level is set.

## To de-select the dual cook zone

### 1 Select cook zone

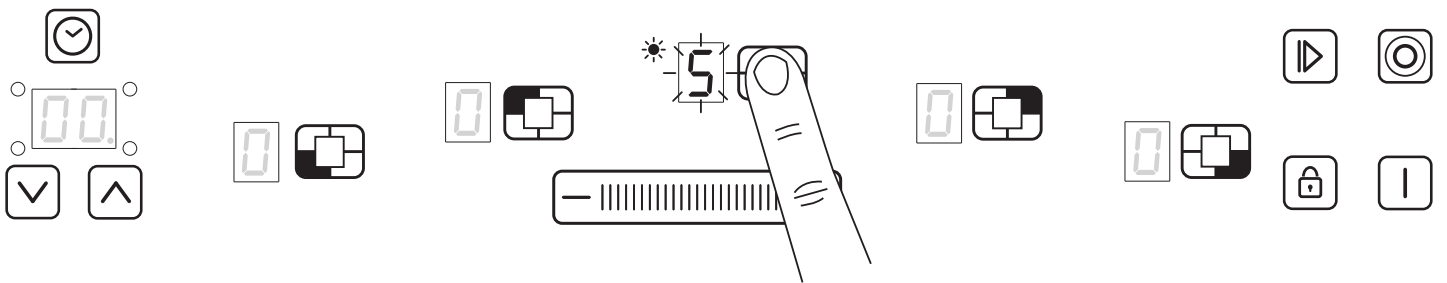

### 2 Use the slider to select power level 0

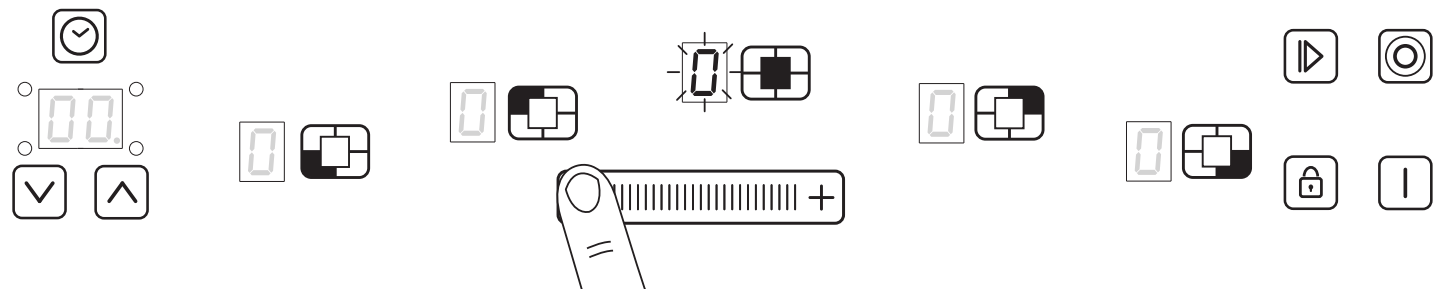

### 3 Press Dual Zone key

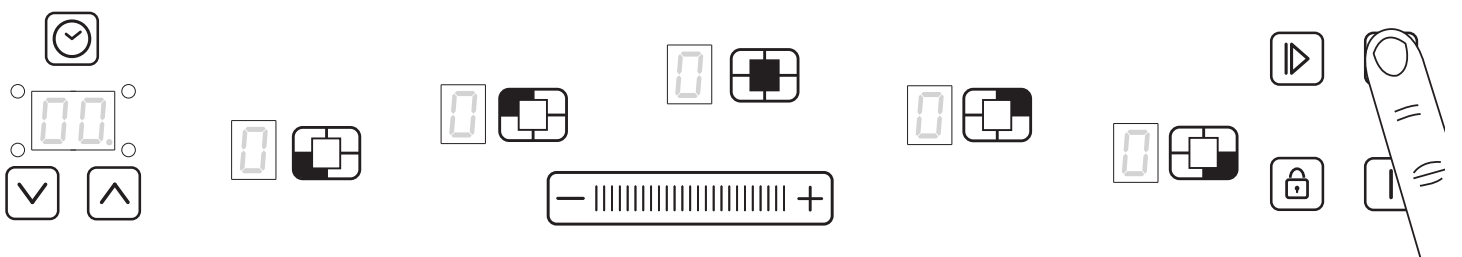

**Note:** Only the inner ring can be operated on its own, the outer ring can only be operated with the inner ring, match your pan accordingly.

## Residual Heat Indicators (for each cook zone)

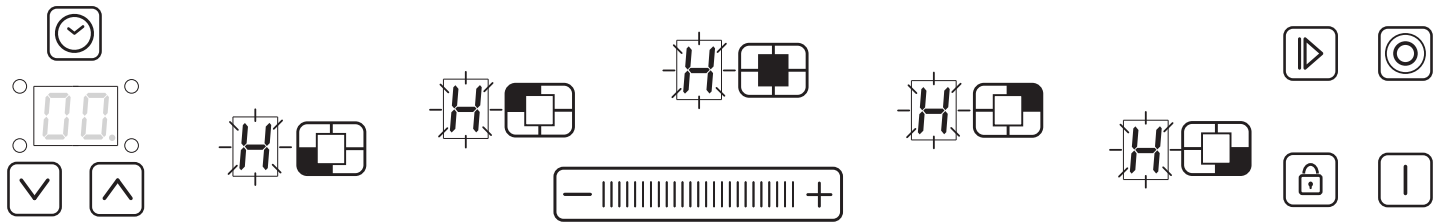

If the glass surface is hot an “H” will be displayed in the cook zone display until the glass has sufficiently cooled.

**Note:** “ H” and “0” will flash alternatively if the cook zone is hot and another cook zone is in use.

## Pause function

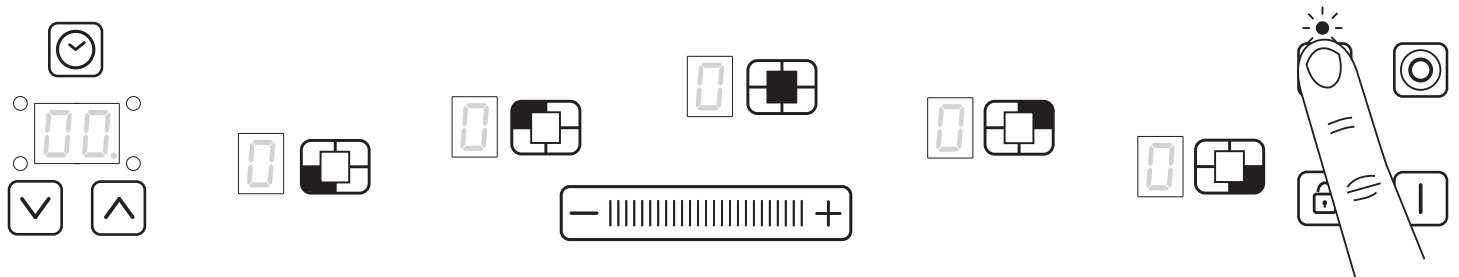

The heaters actual power settings are stored and all the active heaters power are set to 0, the heaters auto switch off time is stopped, all the timers running count downs are stopped, all keys are locked except the Pause key, and the on / off key, no timer will appear on the display, and all the heater LED's display 0

To deactivate, press the pause key.

## Timer (all cook zones)

All 5 cooking zones can be operated under the timer independently and at the same time for up to 99 minutes. When the set time expires the timer will beep and the cook zone will switch off automatically.

## To set the timer

**1** Select the required cook zone

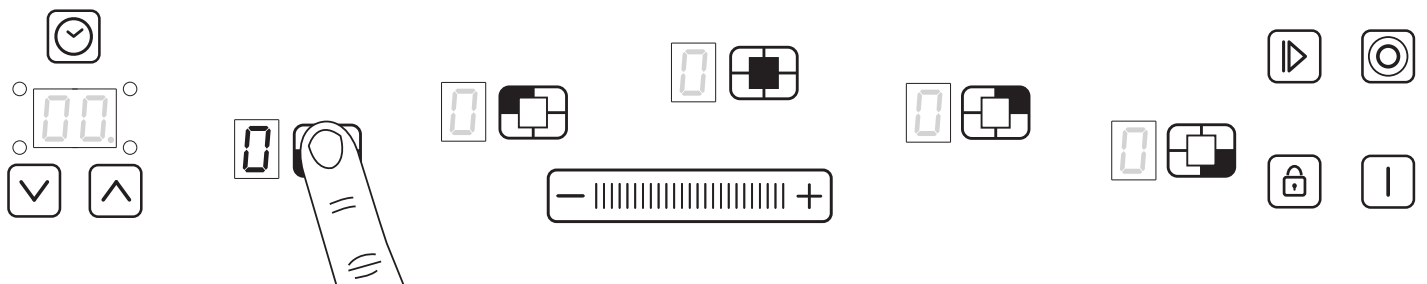

**2** Use the slider to select the power level

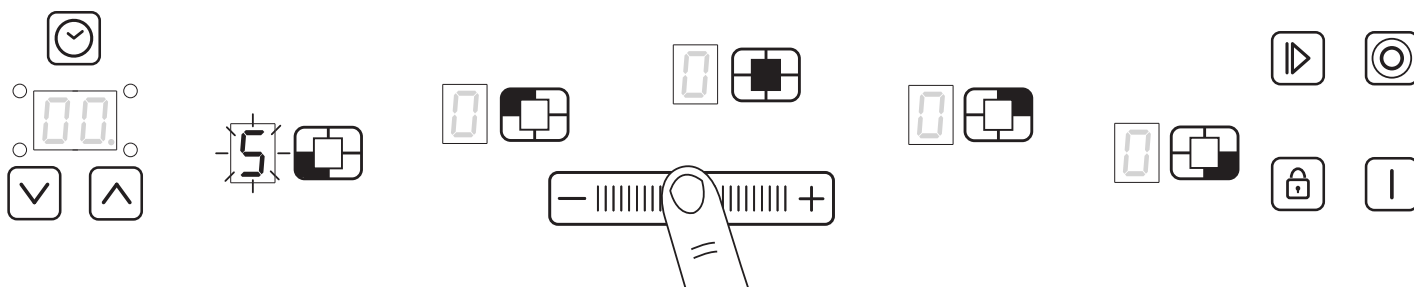

**3** Press the up or down keys to select the timer

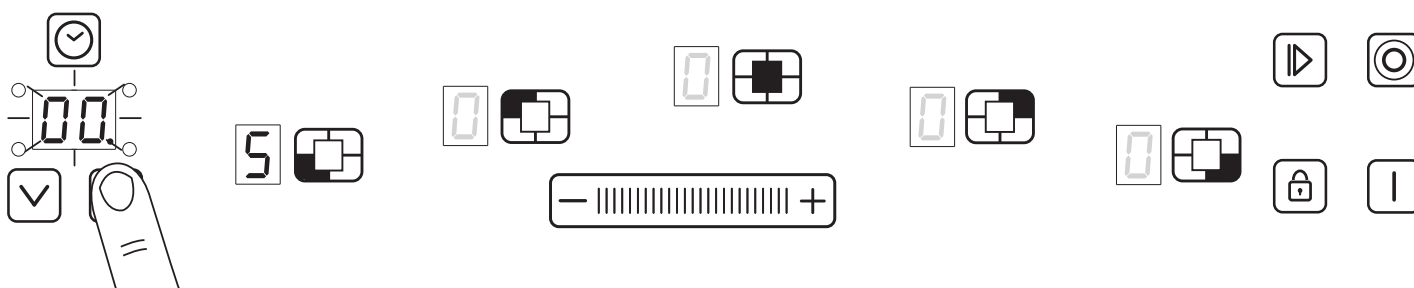

**4** Press the up or down keys to set a time

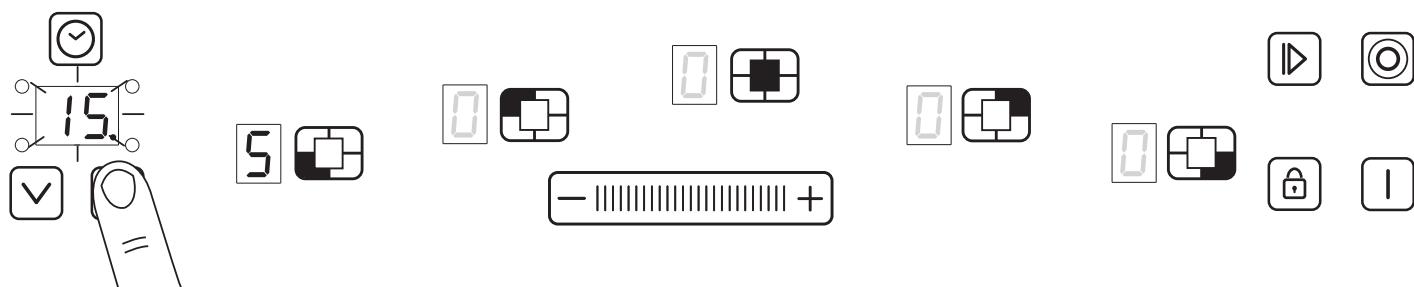

**Note:** Once the time has elapsed, touch the timer key to cancel the alarm. When more than one cook zone is being timed, touch the cook zone key to view the timer.

The cookzone being times is indicated by flashing LED on the timer

### To adjust the timer

Whilst in operation follow steps 1, 2, 3 and 4 from "To set the timer".

### To cancel the timer

Select the cookzone and then return the time back down to '0' or switch off the cook zone.

## **Safety Shut Down**

If the power level is not changed for a long period of time the cook zone will automatically turn itself off. The maximum time a cook zone can stay on depends on the power level.

<b>Power Level</b>	<b>Max Time (Hours)</b>
1	10
2	5
3	5
4	4
5	3
6	2
7	2
8	2
9	1

## **Error Codes**

<b>Hob status codes</b>	<b>Fault Description</b>	<b>Action</b>
FC	Overheat / Temperature Problem	Allow hob to cool then Switch the power off and on, The system will reset and the hob should now be working correctly
FL	Ambient Light Fault	To rectify remove all strong lighting sources and re-apply power.

# CLEANING YOUR APPLIANCE

---

## Do's

**Note:** Always switch off your appliance and allow it to cool down before you clean any part of it.

**Note:** Please take extra care when cleaning over the symbols on the control panel, as this can lead to them fading.

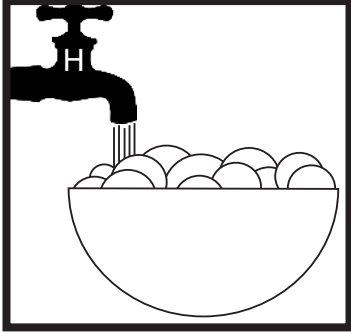

- Warm, soapy water

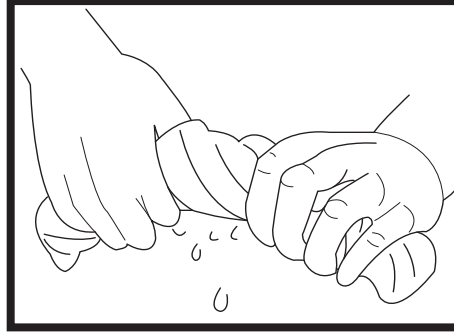

- Clean, wrung out cloth

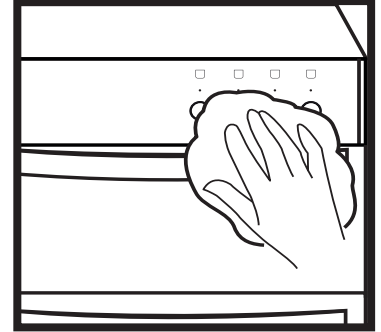

- Wipe with damp cloth
- Dry with a soft cloth

**Tips:** Some foods can mark or damage the metal or paint work e.g.; Vinegar, fruit juices and salt. Always clean food spillages as soon as possible.

## Dont's

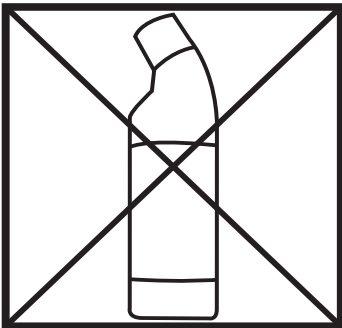

- Undiluted bleaches
- Chloride products

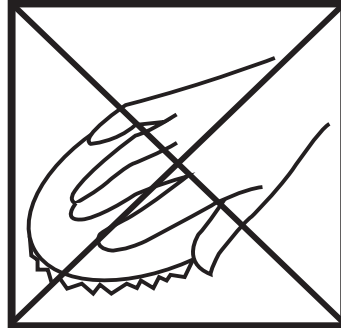

- Wire Wool
- Abrasive cleaners
- Nylon pads
- Steam cleaners

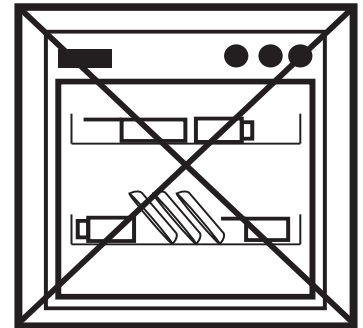

- Do not place in the dishwasher:
- Cast iron griddle
  - Pan supports

**IT IS IMPORTANT TO CLEAN YOUR APPLIANCE REGULARLY AS A BUILD UP OF FAT CAN AFFECT IT'S PERFORMANCE OR DAMAGE IT AND MAY INVALIDATE YOUR GUARANTEE.**

# INSTALLATION INSTRUCTIONS

---

Before you start please read the instructions. Planning your installation will save you time and effort.

**FAILURE TO INSTALL APPLIANCES CORRECTLY IS DANGEROUS AND COULD LEAD TO PROSECUTION.**

Please take care when handling - we recommend the use of protective gloves during installation.

Installation should only be carried out by a competent electrician / qualified technician. We recommend that the appliance is connected by a competent person who is a member of a "Competent Person Scheme" who will comply with the required local regulations. In regions where applicable, please retain your certificate of compliance

Our policy is one of constant development and improvement, therefore we cannot guarantee the strict accuracy of all of our illustrations and specifications. Changes may have been made subsequent to publishing.

**Please keep to the following points most carefully;**

Although every care has been taken to ensure this appliance has no burrs, or sharp edges, we recommend that you wear protective gloves when installing and moving this appliance. This will prevent injury.

The hob should not be fitted above a washing machine, a fridge or a freezer.

Wall surfaces above the work surface and in the immediate vicinity of the cooking hob must be heat resistant. Laminated surfaces and the adhesive used, must be heat resistant in order to avoid any damage.

The space for air circulation, located underneath and at the back of the hob improves its reliability by ensuring that it will cool down, efficiently.

Installations should be carried out in line with the National Regulations applicable for this product type. Make sure that the air inlets through the ventilator grids underneath the hob are never blocked. An air outlet of 5mm underneath work surface is required.

# CHOOSING YOUR INSTALLATION

---

## Installation above an oven

Refer to the manufacturer's instructions for clearances above the oven. We recommend a minimum 20mm gap between the bottom of the hob and appliance, should the work surface be less than 38mm deep

## Installation above a unit with a drawer or door

If necessary, remove the front crosspiece of the unit. The base of the appliance must be protected from damage e.g. drawers may only be installed providing a partition panel is fitted to the required dimensions underneath the appliance.

WHEN UNDERNEATH OF HOB IS ACCESSIBLE BY CONSUMER, A PARTITION MUST BE FITTED - E.G DRAWER, CUPBOARD

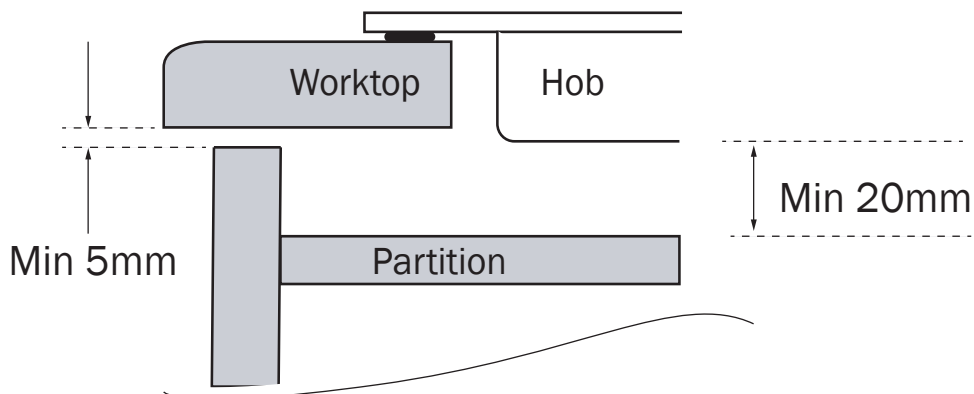

## In the case of a pyrolytic oven

If installing the hob above a pyrolytic oven, additional provision for air circulation / ventilation may be required. Due to the excessive temperatures attained during pyrolysis, using the hob at the same time may cause the thermal safety device within the hob to operate.

# DIMENSIONS AND CLEARANCES

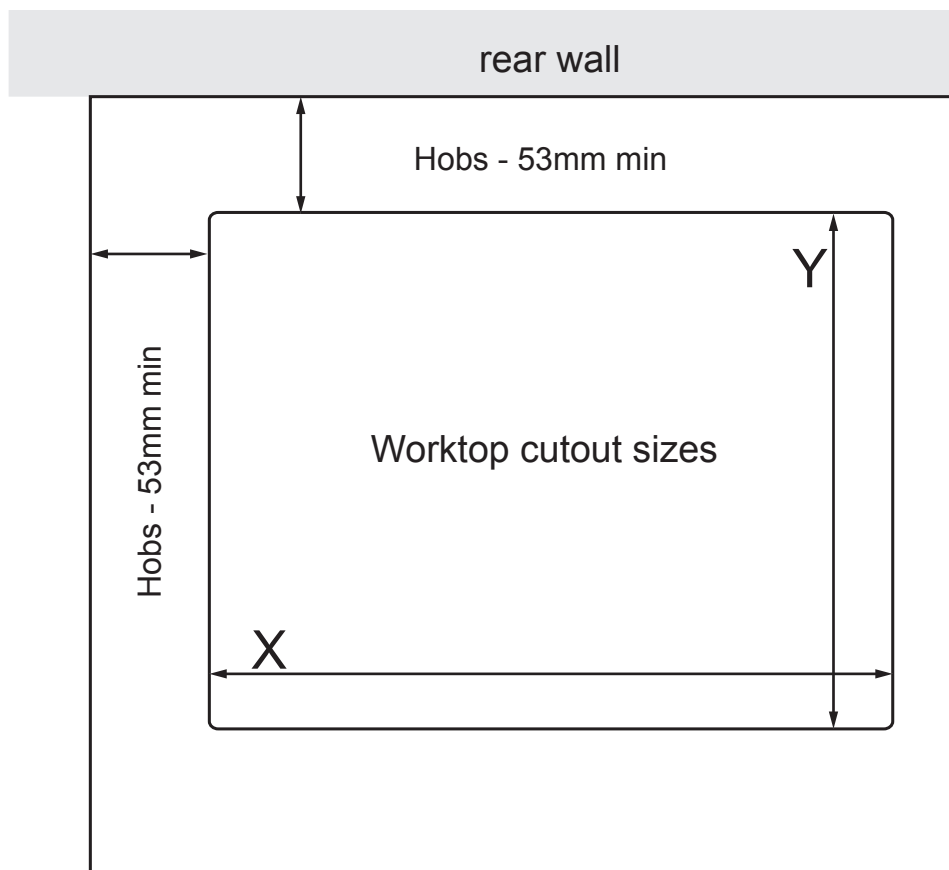

Please see table below for hob cut out dimensions for your appliance

Product	X(mm)	Y(mm)
*60cm hob	560	490
*77cm hob	737.5	487.5

\* The nominal dimensions are shown on the hob cut out table and must be fabricated to a tolerance of +2.0mm -0.0mm with maximum corner radii of 4.0mm

## Fitting into work top

Sufficient length of cable should be allowed so the hob can be removed for servicing, but make sure it is routed away from the underside of the hob & does not get trapped during installation.

**Important:** Ensure that you route all electrical cables and flexible tubing well clear of any adjacent heat source - eg; oven / grill.

## Protecting the cut-out;

The types of chipboard used for work surfaces swell relatively quickly in contact with humidity.

Apply a special varnish or adhesive to the cut edge to protect it from steam or condensation which may form under the work surface under the hob.

This hob can be installed conventionally (glass above the work top) or recessed into the work top for a flush fit.

## Cupboard / hood clearances

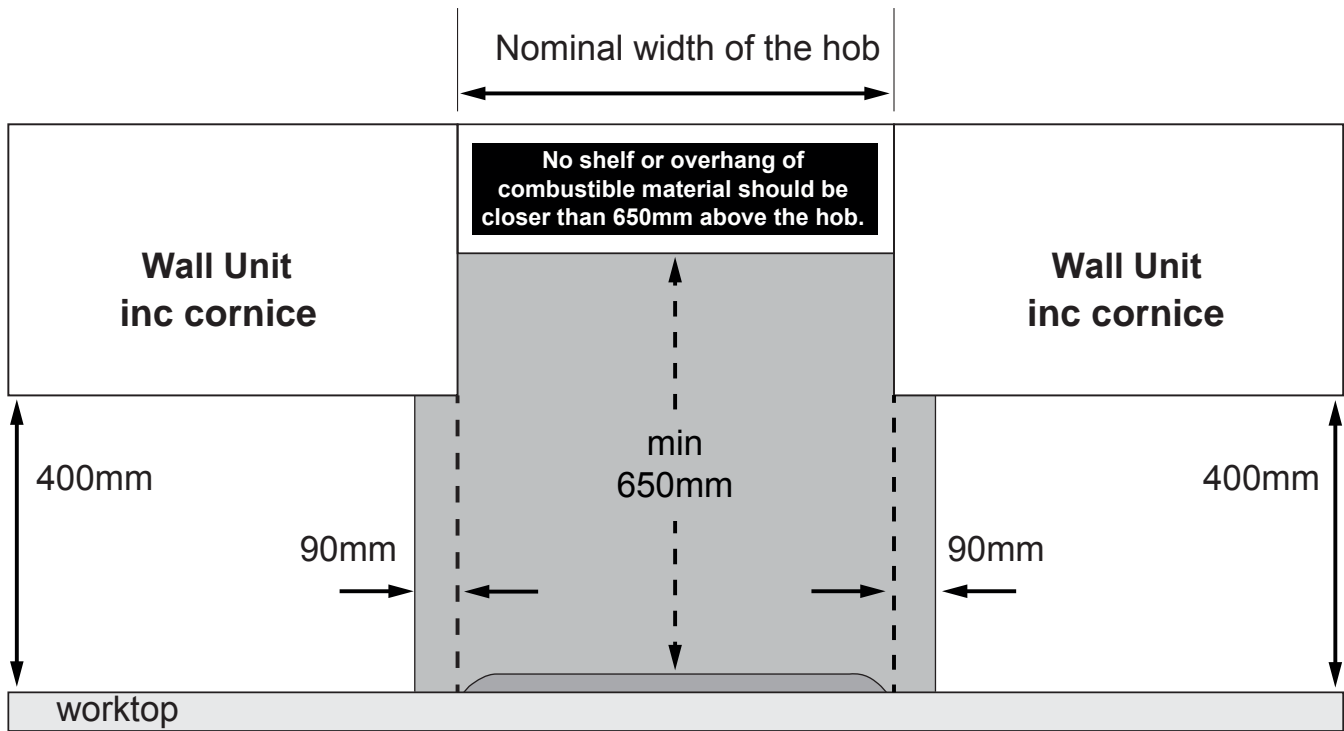

## Self adhesive seal

Apply the self adhesive seal to the underside edges of the hob glass. For best results, the seal should be adhered along each side in turn, as close to the edge as possible, and trimmed at each corner, taking care to ensure a neat join.

## UNDERSIDE OF HOB

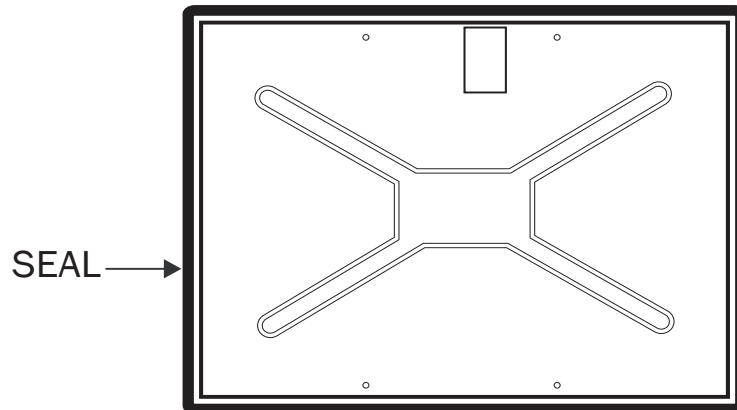

## Conventional Installation

Refer to the installation bracket advice to determine your installation type. Place the hob in the aperture, checking the hob glass is covering the work top along all four sides.

Set the front edge of the appliance parallel with the front of the work top.

## Recessed Method (selected models)

Recess the work top to the appropriate depth (Approx 5mm) and shape to fit the hob (add 1mm to overall glass size).

Refer to the installation bracket advice to determine your installation type. Insert the hob into the recess, ensuring that the foam seal is sitting correctly. You may want to fill any gap between the hob top glass and the work top surface with silicone sealant.

**DO NOT FIT SILICONE SEALANT UNDER THE GLASS HOB INSTEAD OF THE SELF ADHESIVE SEAL.**

### CONVENTIONAL INSTALLATION

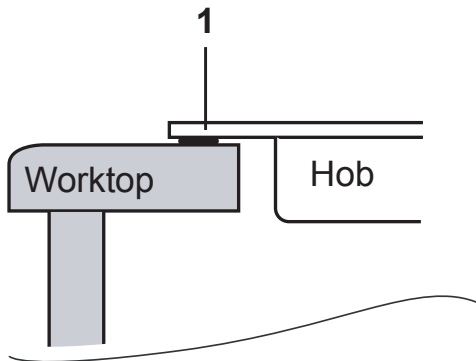

1. Self adhesive seal

### RECESSED METHOD

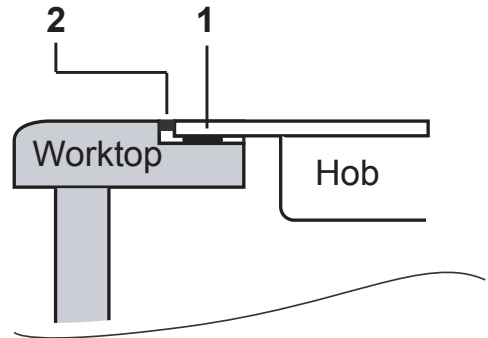

1. Self adhesive seal
2. Silicone sealant

## Push fit hob installation

Your new hob is pre-fitted with push fit installation clips which are designed to simplify the installation procedure and retain the hob into the worktop. Care must be taken to not damage these clips whilst installing this product.

Depending on your product the images below show the push fit clips

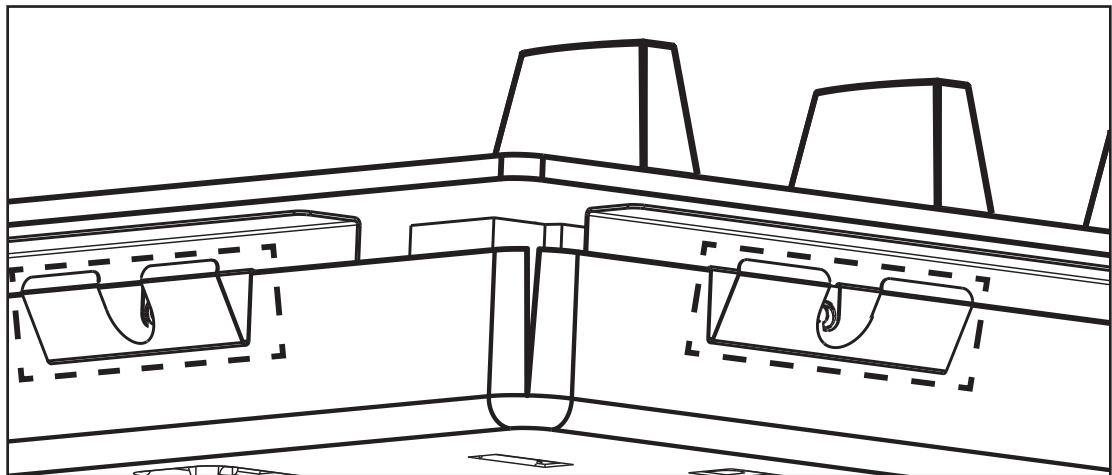
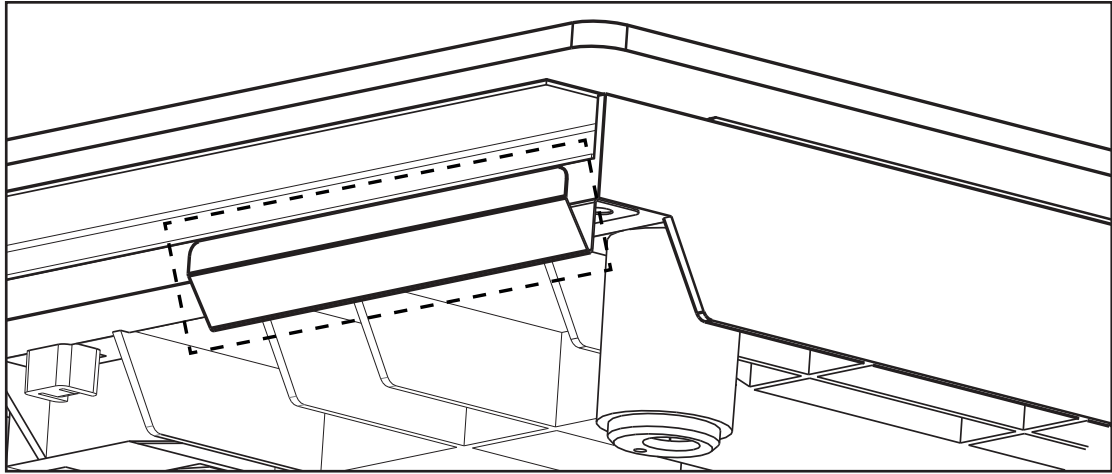

Depending on your product, the images below represents how the system interacts with your worktop.

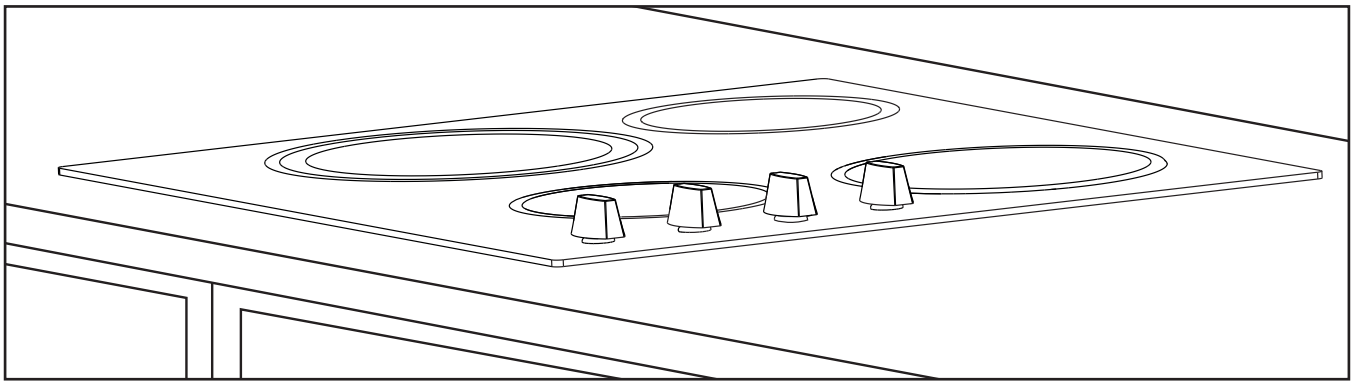
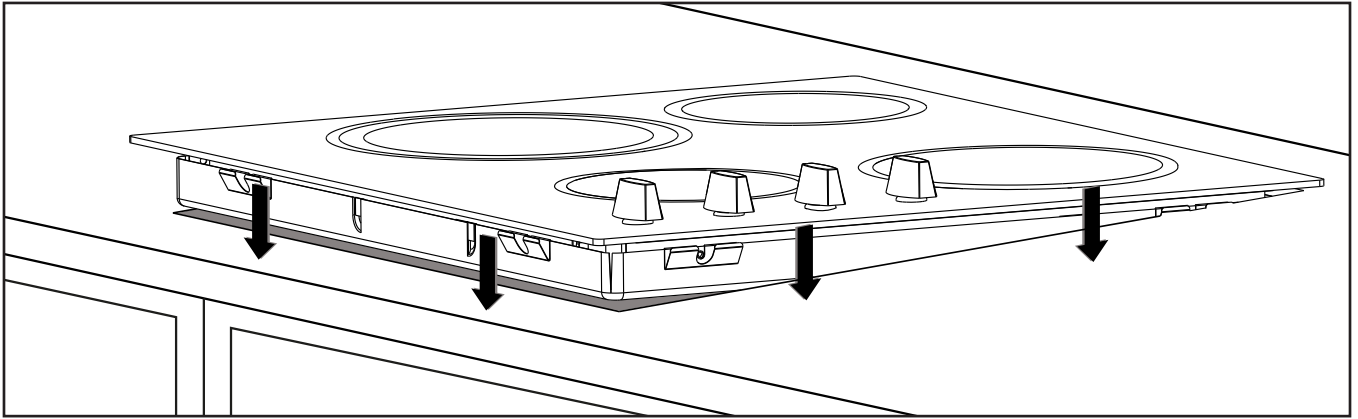

**Note;** The worktop cut out dimensions are critical and will affect the performance of how the push fit system works. The nominal dimensions are shown on the hob cut out table and must be fabricated to a tolerance of +2.0mm -0.0mm. The effectiveness of the system will vary depending on the accuracy of the worktop cut-out dimensions.

The hob seal and wiring must be completed prior to fitting the hob into the worktop. Offer the back edge of the appliance up to the rear of the worktop cut-out keeping the hob central to the cut-out. Care must be taken not to trap the power cable between the hob & the worktop cut-out.

Ensuring nothing is misaligned or trapped, using both hands press down evenly on the front of the hob until it sits in its home position. When doing this, make sure that the seal under the hob sits flush with the worktop on all sides. This is important to ensure an effective seal all around the product. The hob can be removed by applying a small amount of pressure to the underside of the hob.

**Note; If your worktop cutout is oversized, an optional fitting kit can be purchased from our Spares Store.**

# CONNECT TO THE ELECTRICITY SUPPLY

---

⚠ This appliance must be earthed. Only connect to the electrical mains terminal with the power switched off. The electrical mains terminal is live.

Loose and inappropriate connections can make the terminal overheat.

A device must be provided in the electrical installation which allows the appliance to be disconnected from the mains at all poles with a contact opening of at least 3mm.

We recommend that the appliance is connected by a competent person who is a member of a "Competent Person Scheme" who will comply with the required local regulations.

⚠ Ensure that you route all mains electrical cables well away from any adjacent heat source, such as an oven or grill.

For UK installation the hob is pre-fitted with a cable HO5V2V2-F 2.5mm<sup>2</sup>

### 3 PHASE SUPPLY - FOR INSTALLATION IN MAINLAND EUROPE

For connection to a 3 phase supply, the supplied mains cable and bridging links will need to be removed.

- Firstly open the terminal block cover using a small flat bladed screwdriver in the door release tabs shown.
- Remove cable clamp screw and remove mains cable
- Remove 2 bridging links from terminals 1, 2 and 3

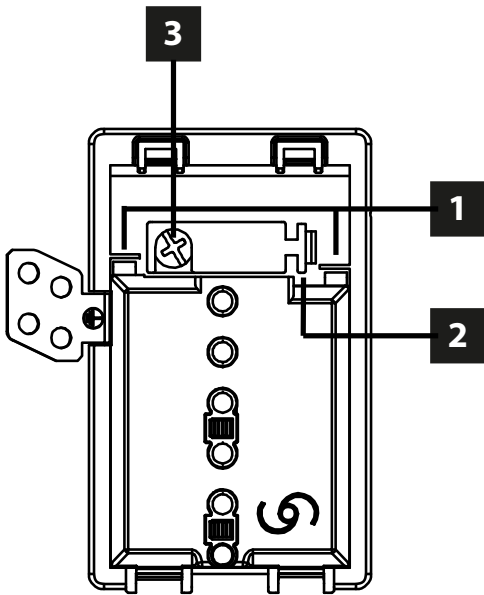

- 1** Door release tab
- 2** Cable clamp ratchet
- 3** Cable clamp screw

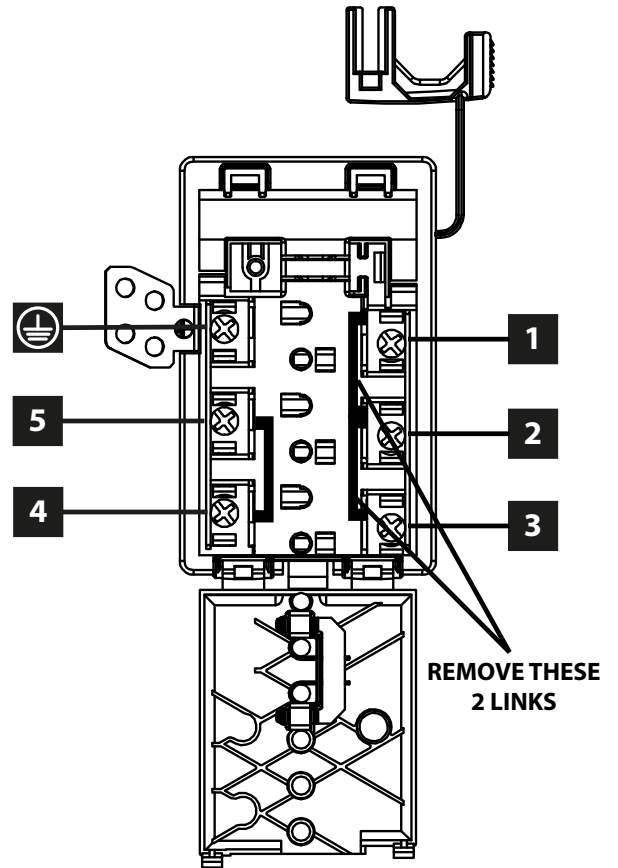

Fit 3 phase mains cable in terminal block as shown in table below;

Wire	Connect to:
L1	1
L2	2
L3	3
Neutral	4 or 5
Earth	

- Fit the cable clamp & secure with the screw provided.
- Close the terminal box, ensuring that the cover is closed and all screws are tight and in place.

**Note;** The cable clamp has a ratchet type mechanism on the right hand side of the retaining arm.

# TECHNICAL DATA

## Electric ceramic hob

Electrical Supply	220~240V 50Hz
Total Power Rating @ 220 - 240V ~ 50Hz (kW)	6.9 kW - 8.2 kW
<b>Hob Details</b>	
<b>Cook Zone</b>	<b>Normal Power Rating kW @ 240</b>
LH Front	1.8
LH Rear	1.2
Center dual	0.75/2.2
RH Rear	1.2
RH Front	1.8

**For the specific power rating of your model, refer to the data badge on the under side of your appliance.**

**Warning:** This appliance must be earthed.

Product Information Commission Regulation (EU) No 66/2014	
LAMONA	
Model	LAM1745
Type of Hob	Ceramic
No of Cooking Zones	5
Heating Technology	Ceramic
Diameter	FL – 180mm RL – 150mm FR – 180mm RR – 150mm Centre – 210mm
EC <sub>electric cooking zone</sub>	FL – 200 Wh/kg RL – 184.5 Wh/kg FR – 200 Wh/kg RR – 194.2 Wh/kg Centre – 185.4 Wh/kg
EC <sub>electric hob</sub>	192.4 Wh/kg

## Product Guarantee Details (UK Only)

*Your appliance has the benefit of a comprehensive manufacturer's guarantee which covers the cost of breakdown repairs. (Details of which are shown on your Proof of purchase Document).*

- Any claim during the period of the guarantee MUST BE ACCOMPANIED BY THE PROOF OF PURCHASE.
- The product must be correctly installed and operated in accordance with the manufacturer's instructions and used for normal domestic purposes.
- This guarantee does not cover accidental damage, misuse or alterations which are likely to affect the product.
- The guarantee is invalid if the product is tampered with, or repaired by any unauthorised person. (The guarantee in no way affects your statutory or legal right)

## What to do if you need to report a problem.

Please ensure you have ready:

- The product's model and serial numbers.
- Howdens Proof of Purchase Document.
- Your full contact details.

Call the Depot number on your Proof of Purchase Document supplied with the product / kitchen.

or

Call the LAMONA Service Line on 0845 00 60 006

\*Product installed within a domestic kitchen or a non-domestic kitchen where 8 or fewer people are using the appliance.

Where to find the model and serial number on your machine.	On the right-hand edge of the door.
--	-------------------------------------

Please keep this handbook for future reference, or for anyone else  
who may use the appliance.



Product serial number  
(Place sticker here)

**LAMONA**  
Exclusive to Howdens Joinery Co.

ISSUE V2 070217