Built-In Single Multifunction Oven

LAM3601



Instructions and Installation

LAMONA

Exclusive to Howdens Joinery Co.

Register
my appliance

www.howdens.com/appliance-registration

Register my appliance

Register your Lamona appliance purchased from Howdens Joinery to allow us to easily contact you in the event of important product updates at:

www.howdens.com/appliance-registration

LAMONA

Exclusive to Howdens Joinery Co.

See back page for product serial number

Dear Customer,
Congratulations on your choice of oven.

The user manual will help you use your product quickly and safely.

- Please read this user manual before installing and using the oven.
- Always follow the safety instructions.
- Keep this user manual within easy reach for future reference.
- Please read any other documents supplied with the product.

Explanation of symbols

Throughout this user manual the following symbols are used:



Important information or useful tips about usage.



Warning for possible hazards to health and property.



Warning possibility of electric shock.

Product information correct at the time of publication in January 2017.

The company has a policy of continuous product development and reserves the right to change any products and specifications given in this manual.



This appliance is marked according to the European directive 2012/19/EU on Waste Electrical and Electronic Equipment (WEEE). WEEE contains both polluting substances (which can cause negative consequences for the environment) and basic components (which can be re-used). It is important to have WEEE subjected to specific treatments, in order to remove and dispose properly all pollutants, and recover and recycle all materials.

Individuals can play an important role in ensuring that WEEE does not become an environmental issue; it is essential to follow some basic rules:

- WEEE shall not be treated as household waste.
- WEEE shall be handed over to the relevant collection points managed by the municipality or by registered companies.
- WEEE can be recycled free of charge.

Index

Before using the oven & Safety	05	Cooking table	16
General	05	Oven cooking table	16
Safety for children	06	Cooking and baking advice	17
Safety when working with electricity	08	Telescopic runner system	18
Shelf positions	09	Installation	19
General information	10	Adjustment	19
Oven layout	10	Care and maintenance	19
Control panel layout	10	Care and maintenance	21
Accessories	10	General information	21
Operation modes	11	Cleaning the oven door	21
Operating modes	11	Removal of oven door	21
Preparation	12	Removal of the inner door glass	22
First cleaning of the appliance	12	Replacing the oven lamp	22
Initial heating	12	Installation	23
Tips for energy saving	12	Before installation	23
How to operate the main oven	13	Installation and connection	24
How to use the main oven	13	Connection to mains supply	24
Select a temperature and operating mode	13	Cooling Fan	25
Shelf positions	13	Technical specification	26
Switch off the oven	13	Troubleshooting	27
Clock Programmer	14	Your Guarantee	28
Minute Minder	14		
Timed Operation	14		
Time Stop Point	14		
Delayed Start Cooking	15		

Before using the Oven

- Make sure that you have removed all packaging, wrappings, stickers and films from the oven's surface.
- It is recommended that you clean and wash the oven's surface before using for the first time (page 12)

-  This appliance is for domestic cooking purposes only. It must not be used for other purposes, e.g room heating, or drying towels and dish cloths over the handle. Commercial use will void the guarantee (see guarantee page).
 - The manufacturer shall not be liable for any damage caused by improper use or handling errors.

General

- This product is not intended to be used by persons with physical, sensory or mental disorders or unlearned or inexperienced people (including children) unless they are supervised by a person who will be responsible for their safety or who will instruct them accordingly in the use of the product.

Safety for children

- Children must be supervised to prevent them from playing with the product.

- Electrical products can be dangerous to children. Keep children away from the product when it is operating and do not allow them to play with or near the product.

•  **CAUTION:** Accessible parts of the oven may become hot when the oven or grill is in use. Children should be kept away until the product has cooled down.”

- Do not store any items above the appliance that children may reach for.
- When the door is open, do not load any heavy object on it and do not allow children to sit on it. The door or door hinges may be damaged.
- The packaging materials will be dangerous for children. Keep the packaging materials away from children. Please dispose of all parts of the packaging according to environmental standards.

- Accessible parts may become hot during use. To avoid burns, children less than 8 years of age should be kept away unless continuously supervised.
- This appliance can be used by children aged 8 years and above, persons with reduced physical, sensory or mental capabilities or lack of experience and knowledge, if they have been given supervision or instruction concerning use of the appliance in a safe way and understand the hazards involved.
- Cleaning and user maintenance must not be made by children without supervision.
- Connect the product to an earthed outlet protected by a fuse of suitable capacity as stated in the “Technical specifications” table. Our company shall not be liable for any problems arising due to the product not being earthed in accordance with the local regulations.
- Do not operate the product if the power cable is damaged. Replace with a suitable cable by a qualified person.
- Do not operate the product if it is defective or has any visible damage.
- Do not carry out any repairs or modifications to the product.
- Never wash down the product with excessive water, as there is the risk of electric shock!
- Never use the product when your judgment or coordination is impaired by the use of alcohol and/or drugs.
- Product must be disconnected from the mains during installation, maintenance, cleaning and repair procedures.
- Repair procedures must always be performed by qualified persons. The manufacturer shall not be held responsible for damages arising from procedures carried out by unauthorised persons, which may also void the guarantee.
- Be careful when using alcoholic drinks in your dishes. Alcohol evaporates at high temperatures and may ignite when it comes into contact with hot surfaces.

- Do not heat closed tins and glass jars in the oven. The pressure that would build-up in the tin/jar may cause it to burst.
- Do not place any materials close to the product as the sides may become hot during use.
-  **WARNING FIRE RISK - Do not place aluminium foil, baking trays or cook on the base of this oven, doing so will cause permanent damage to your appliance and cabinetry with the potential risk of fire.**
- Parts of the oven may become hot during or immediately after use. Care should be taken to avoid touching the heating elements, and components inside the oven which maybe hot. Always allow oven to cool.
- If the door seal is very dirty this can prevent the door from closing properly during use, resulting in possible damage to adjacent furniture and poor efficiency. Always ensure the door seal is clean.
- Product may become hot when it is in use. Please be careful not to touch these hot surfaces.
- Always use heat resistant oven gloves when putting dishes in or removing dishes from the hot oven.
- Do not use the product if any door glass is removed or damaged.
- Rear surface of the oven may get hot when it is in use. Make sure that the electrical connections do not contact the rear surface; otherwise, connections may be damaged.
- Do not trap the mains cable and do not route it over hot surfaces. The cable insulation may melt and cause a short circuit.
- Product must be installed by a qualified person in accordance with the regulations in force. Otherwise, the guarantee may become void.
- When hot and cold air meet, condensation can form. The outer door is air cooled and the inner glass will become hot during cooking, therefore some condensation might form. This is perfectly normal. All condensation will disappear as the oven reaches cooking temperature.





- Make sure that the product control knobs are switched off after every use.

Safety when working with electricity

- Any work on electrical equipment and systems should only be carried out by authorised or qualified persons.
- In case of any damage, switch off the product and disconnect it from the mains. To do this, turn off at the fuse box.
- The appliance must be installed so that it can be completely disconnected from the mains easily after installation by the isolation switch.
- Do not bend or trap cable against hot surfaces during install.
- Make sure that fuse rating is compatible with the product.
-  **Do not switch the oven off at the mains isolation switch immediately after cooking. Cooling fan continues to run for up to 20-30 minutes (approx) even after the oven control is turned off.**

- Keep all ventilation slots clear of obstructions, as this may cause premature failure of the oven element.
- Do not allow the oven to cool with the door open. Even if the appliances door is only open a little, front panels of adjacent units could become damaged over time.

Safety and cleaning

-  Do not use harsh abrasive cleaners or sharp metal scrapers to clean the oven door since they can scratch the surface, which may result in the shattering of the glass.
-  **WARNING** Ensure that the appliance is switched off before replacing the lamp to avoid the possibility of an electric shock.
-  Do not use oven light for household room illumination.
-  Do not use steam cleaners for cleaning.
- The appliance must not be installed behind a decorative door.

Shelf positions

The oven has 5 shelf positions. It is important to position the wire shelf into the runners correctly before placing items on the shelf. Do not insert shelves forcefully.



General Information

Oven layout

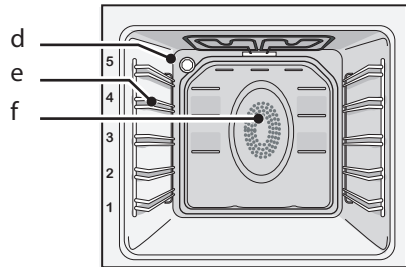
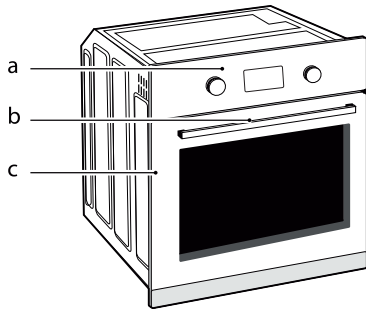

- a. Control panel
- b. Handle
- c. Oven Door

- d. Oven Light
- e. Side Racks
- f. Fan Heating Element

Control panel layout

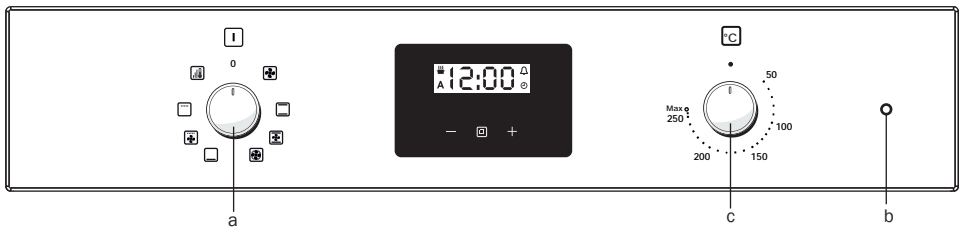

- a. Oven / grill function knob
- b. Main oven temperature indicator
- c. Oven / grill temperature control knob

Accessories

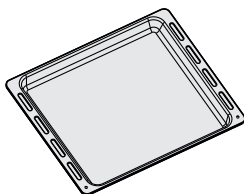

Oven tray / grill pan



Grill pan wire rack / trivet



Oven shelf (x2 included)

Operating modes

Operating modes

All functions for the ovens and grill are listed in this section. Please note* depending on the model of your oven, the number and order of operating modes available may deviate from the illustrations shown below.



Defrost*

The oven is not heated. Only the fan (in the rear wall) is in operation.

Frozen granular food can be thawed slowly at room temperature, and cooked food can be cooled down.



Bottom heat*

Only bottom heat is used. Is particularly suitable for dishes, such as pizza, which are required to be baked from beneath.



Top and bottom heat*

Top and bottom heat is used. The foodstuffs are heated simultaneously from above and below.

Suitable for cakes, cookies and casseroles. For best results cook with one tray only.



Fan-Grill*

The grill effect is not as strong as with the full grill and heat is distributed more evenly.



Grill - Full*

The full grill element in the top oven is in operation. This is suitable for grilling larger dishes.

Ensure correct shelf position is used, set the temperature to desired level, and turn the food as required to ensure even cooking.



Fan Assisted cooking*

Top and bottom heat plus fan (in the rear wall) are on. The hot air is distributed evenly and quickly all over the oven by the fan.



Fan Cooking*

The element & fan (in the rear wall) are both in operation. Hot air is distributed evenly and quickly all over the cavity by the fan. In most cases, preheating is not required. This mode is suitable when several levels are used for the cooking and an even temperature is required throughout the oven cavity.



Rapid Preheat / Boost*

This mode is used for heating the oven quickly and is unsuitable for the preparation of food.

After selecting this mode, choose the desired temperature.

The thermostat lamp is lit and the oven is heated rapidly. When the heating process is completed, the lamp goes off. Now you select the desired operating mode for the preparation of food.

Preparation

First cleaning of the appliance

1. Remove all packaging materials.
2. Wipe the surfaces of the appliance with a damp cloth or sponge and dry with a clean cloth and mild detergent.

The surface may get damaged by some detergents or cleaning materials.

Do not use aggressive detergents, cleaning powder/cream or any sharp objects or abrasives.

Initial heating

It is recommended to heat up the product for about 30 minutes and then switch it off. Thus, any production residues or layers will be burnt off and removed.

1. Take the tray and the wire grid out of the oven.
2. Close the oven doors.
3. Select the highest oven & grill power levels (See How to use the oven and grill section).
4. Operate oven & grill for about 30 minutes.
5. Turn off your oven & grill and allow to cool.



Small amounts of fumes may emit during the initial heating process; this is normal, however monitor the oven at all times and ensure that the room is well ventilated.

Tips for saving energy

The following information will help you to use your appliance in an ecological way, and to save energy:

- Use dark coloured or enamel coated cookware in the oven as the heat transmission will be better.
- Perform a preheating operation if it is advised in the user manual or cooking instructions.
- Do not open the door of the oven frequently during cooking.
- Try to cook more than one dish in the oven at the same time whenever possible. You can place two cooking vessels onto the wire shelf.
- Cook one dish after another. The oven will already be hot.
- You can save energy by switching off your oven a few minutes before the end of the cooking time. Do not open the oven door.
- Defrost frozen dishes before cooking them if possible if applicable.

How to operate the main oven and grill

Setting the correct time





WARNING: The oven will not operate until clock is set.

When first switched on the clock display will flash '12.00'

Touch the + or - buttons whilst the display is flashing to adjust the time. (The display stops flashing after 5 sec and time is displayed).

To adjust clock time:

Press mode button  x 4 times until clock symbol  is displayed. Touch the + or - buttons whilst display is flashing to set the time of day. (The display stops flashing after 5 sec and time is displayed).

Select temperature & Operating mode

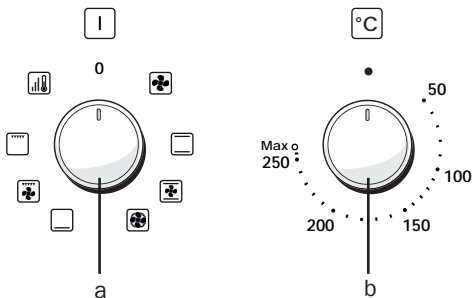

- a. Oven / grill function knob
b. Oven / grill thermostat knob

The operating modes of the electric oven are selected with the function knob. The temperature is adjusted with the thermostat knob.

How to use the Oven & Grill

1. Set thermostat knob to the desired temperature.
2. Set function knob to the required operating mode.
3. **Close the oven door**

The oven heats up to the adjusted temperature and maintains it. During heating, the temperature indicator light will remain on until the desired temperature is reached.

Shelf positions

The oven has 5 shelf positions as illustrated below. It is important to position the wire shelf into the runners correctly.



Please ensure shelves are fully inserted before closing the oven door, failure to do so could lead to damage to the door.

Warning -Do not place aluminium foil or baking trays on the base of the oven. This can lead to permanent damage to your appliance.

Warning -Do not place plates, dishes or trays on the floor of oven cavity when oven is in use.

Warning - Do not use the oven or grill cavity for storage when not in use.



Switch off the electric oven

Turn function knob and thermostat knob to off position (top).



Clock Programmer

Minute Minder (0.01 min - 2.30hr)



Press mode button  x 3 times until alarm symbol  is displayed. Touch the + or - buttons to set the desired time duration. The alarm will sound when the selected time has elapsed. Touch any button to stop alarm

To Cancel:

Press mode button  x 3 times until alarm symbol  is displayed. Touch the + or - buttons to set the duration to 00.00.

Timer Cooking

Timed Operation Period

Oven cooks for a selected time period then stops: (0.01min to 10.00 hr)



Press mode button  x 1 time until Cook symbol  is displayed and flashing.

Touch the + or - buttons to set the desired cooking time duration. (Display reverts to time of day after desired time period is set and  symbol remains lit)

Select desired oven cooking mode and temperature using the oven control knobs.



The alarm will sound and the Cook symbol  will flash when the selected cooking time has elapsed.

Turn oven control knobs to 'Off' and touch any button to stop alarm and return oven to 'Manual' use mode.

To Check time left:

Press mode button  x 1

To Cancel:

Press mode button  x 1 time until Cook symbol  is displayed.

Touch the + or - buttons until alarm sounds and display shows 00.00. Clock time returns.

Note: Whilst cook symbol  is flashing the oven cannot be used in 'Manual' mode.

Time Stop Point

Oven cooks until a designated time then stops: (up to 23.59 hr)



Press mode button  x 2 times until symbol **A** is displayed and flashing.

Touch the + or - buttons to set the desired stop time. (Display reverts to time of day after desired stop time is set and **A** symbol remains lit).

Select desired oven cooking mode and temperature using the oven control knobs.

The alarm will sound and the **A** symbol will flash when the selected time has been reached.

Turn oven control knobs to 'Off' and touch any button to stop alarm and return to 'Manual' use mode. (Timer will sound for 2 mins then stop if no button is pressed).

To Cancel:

Press mode button  x 2 times until **A** symbol is displayed.

Touch the + or - buttons until **A** flashes, alarm sounds and time of day returns.

(Timer sounds for 2 mins then stops if no button is pressed).

Delayed Start Cooking

The two timed cooking modes can be combined to create a delayed start cooking period.

Programme a Timed Operation Period

(as described on p14).

Then

Programme a Time Stop Point

(as described on p14).





Both symbols **A** and  will be displayed and the cooking process will start at a future point in time e.g.

If Time Stop Point is set to 16.00 and Timed Operation Period is set to 1.30 hrs

- The oven will switch on at 14.30 and cook until 16.00

To Check Settings:

Push mode button  x 1 to see  cooking period.

Push mode button  x 2 to see **A** cooking end time.

To Cancel:

Press mode button  x 1 time until Cook symbol  is displayed.

















Touch the + or - buttons until alarm sounds and display shows 00.00 Clock time returns.

Cooking Tables

 The values indicated in the tables below are indicative. They may vary according to the type of food, the quantity and your preferences of cooking.

 **Baking and roasting**
Level 1 is the lowest shelf level.

Oven cooking table

MAIN OVEN COOKING TABLE				
Dish	Shelf Level	Oven Function	Temperature °C	Cooking Time min
Baking				
Cakes in tray*	1 = level 3		175	30 - 40
	2 = level 1 & 5		175	45 - 50
Cakes in mould*	1 = level 2		175	50 - 60
Cakes in bun cases	1 = level 3		175	25 - 35
	2 = level 1 & 5		175	35 - 45
	3 = level 1,3 & 5		180	45 - 55
Sponge cake*	level 3		200	15 - 20
Cookies*	1 = level 3		175	25 - 30
	2 = level 1 & 5		170 ... 190	35 - 45
	3 = level 1,3 & 5		175	30 - 40
Dough pastry*	1 = level 2		200	35 - 45
	2 = level 1 & 5		200	50 - 60
	3 = level 1,3 & 5		200	55 - 65
Rich pastry*	1 = level 2		200	25 - 35
	2 = level 1 & 5		200	35 - 45
	3 = level 1,3 & 5		190	45 - 55
Meat				
Lasagne*	level 1 or 2		200	30 - 40
Roast Beef	level 3		25 min at 230/max then 180 ... 190	100 - 120
Leg of Lamb	level 3		25 min at 220 then 180 ... 190	70 - 90
Roasted chicken	level 2		25 min at 230/max then 180 ... 190	55 - 65
Turkey (5.5kg)	level 1		15 min at 230/max then 190	150 - 210
Fish				
Fish	level 3		200	20 - 30

When cooking with 2 trays at the same time, place the deeper tray on the upper rack and the other one on the lower rack.

* It is suggested to perform preheating for all foods

If cooking requires preheating, heat the oven until the thermostat lamp goes out.

Cooking and baking advice



Risk of scalding by hot steam! Take care when opening the oven door as steam may escape.

Tips for baking

- Use nonstick coated appropriate metal trays and containers or heat-resistant silicone moulds.
- Make best use of the space on the shelf.
- It is recommended to place the vessels in the middle of the shelf.
- Select the correct shelf position before turning the oven or grill on - don't move oven shelves when hot.
- Keep the oven door closed.

Tips for roasting

- Seasoning with lemon juice and black pepper will improve the cooking performance when cooking a whole chicken, turkey or a large piece of meat.
- Meat with bones takes about 15 to 30 minutes longer to cook than a roast of the same size without bones.
- Let meat rest in the oven for about 10 minutes after the cooking time. The juices will be better distributed throughout the meat and will not run out when the meat is cut.
- Fish in a heat proof dish should be placed at the medium or lower level.

Tips for grilling

- Grilling is ideal for cooking meat, fish and poultry and will achieve nice browning without drying out the food. Flat pieces, meat skewers and sausages are particularly suited for grilling, as are vegetables with a high water content, such as tomatoes and onions.
- Distribute the pieces to be grilled on the wire rack.
- Use tray or grill pan under the wire rack in order to collect dripping fat or juices.
- Adding some water to the grill pan will assist with cleaning.

Tips for baking cake

- If the cake is too dry, increase the temperature by 10 °C and decrease the cooking time.
- If the cake is wet, use less liquid or lower the temperature by 10 °C.
- If the cake is too dark on top, place it on a lower shelf, lower the temperature and increase the cooking time.
- If cooked well on the inside but sticky on the outside use less liquid, lower the temperature and increase the cooking time.

Tips for baking pastry

- If the pastry is too dry, increase the temperature by 10 °C and decrease the cooking time. Dampen the layers of pastry with a wash composed of milk, oil, egg.
- If the pastry takes too long to bake, pay attention to the thickness of the pastry you have prepared
- If the upper side of the pastry gets browned, but the lower part is not cooked, make sure that the amount of wash you have used for the pastry is not too much at the bottom of the pastry. Try to spread the wash equally over the pastry for an even browning.
- Cook the pastry in accordance with the mode and temperature given in the cooking table.

Tips for cooking vegetables

- If the vegetable dish runs out of juice and gets too dry, cook it in a dish with a lid instead of an open tray. Closed vessels will preserve the juice of the dish.
- If a vegetable dish is not cooked, boil the vegetables beforehand.

Telescopic Shelf Runner System

Your appliance is compatible with Lamona's telescopic oven shelf and grill pan runners.

The shelf runners have been engineered to provide a safe and convenient way of serving directly from the grill pan or oven shelf even at full extension by utilising ultra smooth sliding mechanism.

These runners may already be supplied with your appliance, or can be purchased as an optional extra from your local Howdens depot to be fitted retrospectively.

General

⚠ The shelf runners are designed for domestic purposes only, and should be used in combination with Lamona ovens only. They must not be used for any other purposes, including commercial use which will void the guarantee.

The manufacturer shall not be liable for any damage caused by improper use, installation or handling errors

Safety

⚠ These runners are not intended to be fitted or used by persons with physical, sensory or mental disorders or unlearned or inexperienced people (including children) unless they are supervised by a person who will be responsible for their safety or who will instruct them accordingly in the use of the product.

- Before attempting to install or adjust the telescopic shelf runners please ensure the oven is turned off and all surfaces have had sufficient time to fully cool.
- the runners will become hot when in use. Please be careful not to touch these hot surfaces.
- Never wash down the product with excessive water

- Repair procedures must always be performed by qualified service agents. The manufacturer shall not be held responsible for damages arising from procedures carried out by unauthorised persons, which may also void the guarantee.

Components

- 1) Telescopic runners. (Left and Right handed)
- 2) Wire cavity racks. (Left and Right handed)

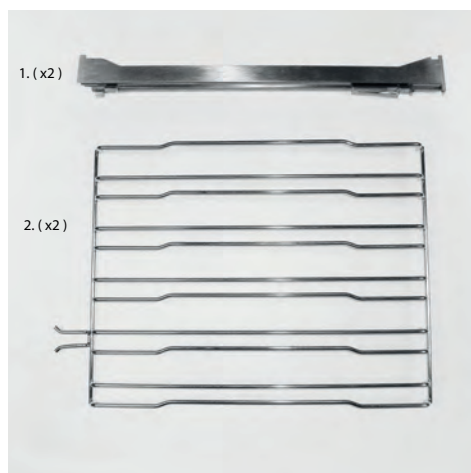

Installation

Before fitting the telescopic runners it may be necessary to remove and replace the existing wire cavity racks.

⚠ Please Note: if your appliance is originally supplied with telescopic runners, the wire cavity racks will not need replacing, therefore please skip directly to adjustment section.

1. To begin installation ensure the appliance cavity is cool to the touch and the power is switched off.
2. Remove all existing grill pans and shelves.
3. Use a large cross headed screwdriver to loosen the tensioning bolts towards the rear of the cavity.

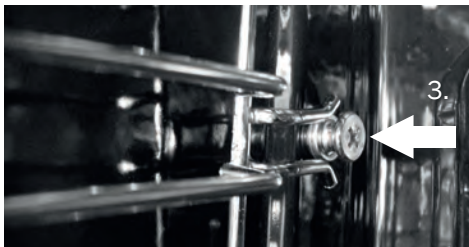
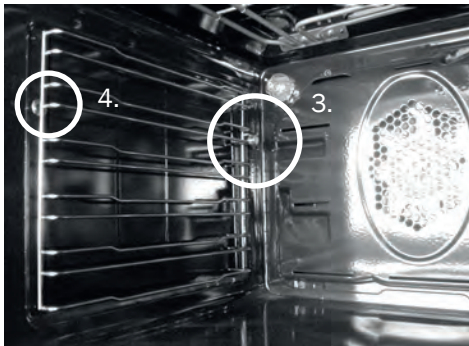

⚠ Please Note: its not necessary to completely remove these bolts, merely loosen them.

4. The front edge of the wire cavity racks can then be Un-clipped from the oven cavity and set aside.

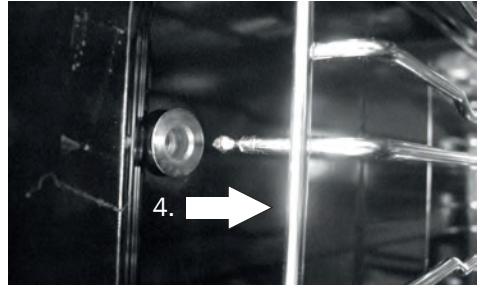

5. Replace the wire cavity racks with the new ones supplied by reversing the above process, ensuring you remember to re-tighten the tensioning bolts.

Adjustment

The telescopic runners can be re positioned at various levels to suite your needs.

6. To begin adjustment ensure the appliance cavity is cool to the touch and the power is switched off.
7. Remove all existing grill pans and shelves.
8. Approaching at an angle, hook the rear edge of the telescopic runner onto any one of the **bent** wires (as pictured below)

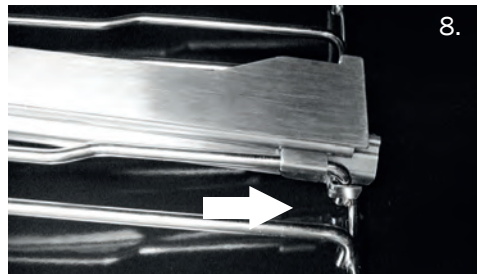

9. Push the runner towards the rear of the oven cavity, and rotate it until a click can be heard

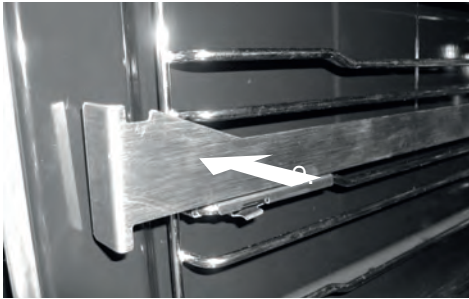

10. Repeat this process for the opposing side of the oven, ensuring both runners are located at the level.
11. Finally extend both runners to their full extent and position the grill pan or shelf on top, aligning the front edge with the notch in the brackets.

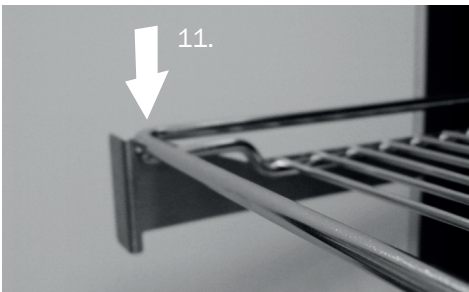

12. The runners can be removed and repositioned by gently flexing the sprung clip downwards (pictured below) and reversing the above process.

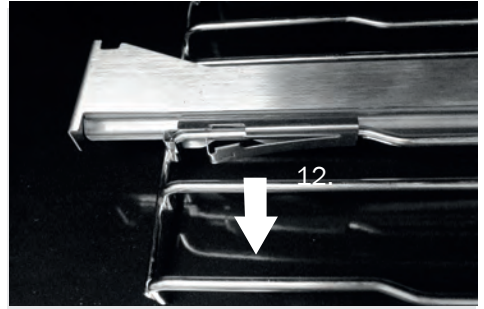

Care & maintenance

The runners are designed to give you good service and last the life time of your oven.

⚠ Never use any un-approved lubricants as this may become a fire risk.

All components can be removed for cleaning with a warm damp cloth and mild detergent.

The shelf runners should never be submerged, cleaned with excessive water or be left to soak in water.

Care and maintenance

General information

Service life of the product will extend and the possibility of problems will decrease if the product is cleaned at regular intervals.



Risk of electric shock!

Switch off the electricity before cleaning appliance to avoid possibility of an electric shock.



Hot surfaces may cause burns!

Allow the appliance to cool down before you clean it.

- Clean the product thoroughly after each use. This way it will be possible to remove cooking residues more easily and will avoid burning them on the next time the appliance is used.
- No special cleaning agents are required for cleaning the product. Use warm water with washing liquid, a soft cloth or sponge to clean the product and wipe with a dry cloth.
- Always ensure any excess liquid is thoroughly wiped off after cleaning and any spillage is immediately wiped dry.
- Do not use cleaning agents that contain acid or chloride to clean the stainless steel surfaces and the handle.

Use a soft cloth with a liquid detergent (not abrasive) to wipe those parts clean, paying attention to sweep in a horizontal direction.



The surface may be damaged by some detergents or cleaning materials.

Do not use aggressive detergents, abrasive cleaning powder/cream or any sharp objects.

Do not use steam cleaners for cleaning.
Cleaning the control panel

Clean the control panel and control knobs with a damp cloth and wipe them dry.

Do not remove the control knobs for control panel cleaning.

Cleaning the Oven Door

Don't use any harsh abrasive cleaners or sharp metal scrapers for cleaning the oven door. They could scratch the surface and damage the glass.

Removal of the Oven Door

1. Open the door.
2. Unlock the clips at the hinge housing on the right and left hand sides of the door by pressing them down as illustrated in the diagram.

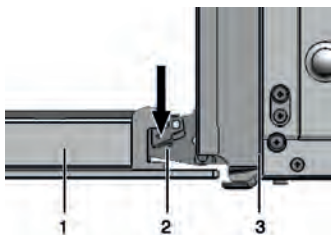

1. Door door
2. Clips
3. Oven

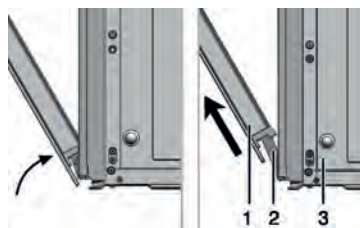

4. Raise the door to the half-way position.
5. Remove the door by pulling it up-wards to slide it from the hinges.

Steps carried out during removing process should be performed in reverse order to reattach the door.



Do not forget to close the clips at the hinge housing when reinstalling the door.

Removing the Inner Door Glass

The inner glass panels of the door can be removed for cleaning.



When cleaning, avoid the use any harsh abrasive chemicals or sharp metal scrapers as this could scratch the surface and damage the glass.



Please be aware when removing and cleaning the glass that the door has the potential to spring closed. We recommend you support the door at all times or remove the entire door assembly prior to attempting to clean it.

In order to do this:

1. Open the door fully.

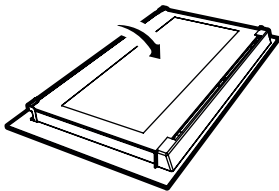

2. The top plastic cap can be pulled away from the retaining clips.

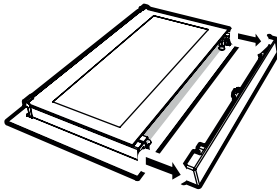

3. The upper glass can be slid out of its retaining slots and the inner glass can be removed.

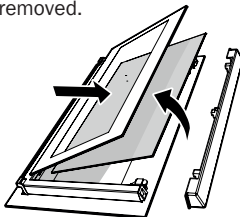

4. To replace the glass follow this process in reverse ensuring the printed surface of the glass is facing downwards.



Ensure the glass is fully located in the lower retaining slots before attempting to re-fit the top cap.

To clean the side wall

1. Remove the front section of the side rack by pulling it in the opposite direction of the side wall.
2. Remove the side rack completely by pulling it towards you.

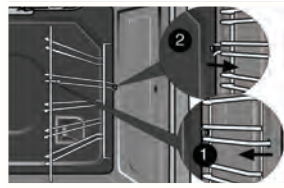

Replacing the Oven Lamp



Hot surfaces may cause burns

Make sure that the appliance is switched off and cooled down in order to avoid the risk of an electric shock or burns.



The oven lamp is a special lamp that can resist up to 300°C. (See technical specifications)

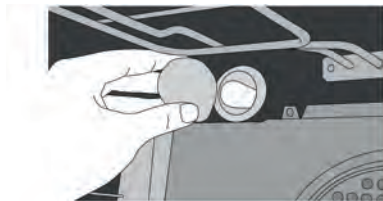

1. Disconnect the oven from the mains.
2. Turn glass outer cover counter clockwise to remove.
3. Remove oven lamp by turning counter clockwise. (Dispose of carefully).
4. Replace with new lamp.
5. Replace glass outer cover.

Installation

Before installation

The product should only be installed by suitably qualified persons.



The product must be installed in accordance with all local regulations.



Prior to installation, visually check the product for any damage/defects. Do not install if any issues are found.

Damaged products may cause risks to your own safety.

The appliance is intended for installation in Howdens kitchen cabinets.

- Surfaces, synthetic laminates and adhesives used must be heat resistant.
- Kitchen cabinets must be set level and fixed.
- If there is a drawer beneath the oven, a shelf must be installed between oven and drawer.
- The following installation drawings are representational and may not match exactly with your appliance.

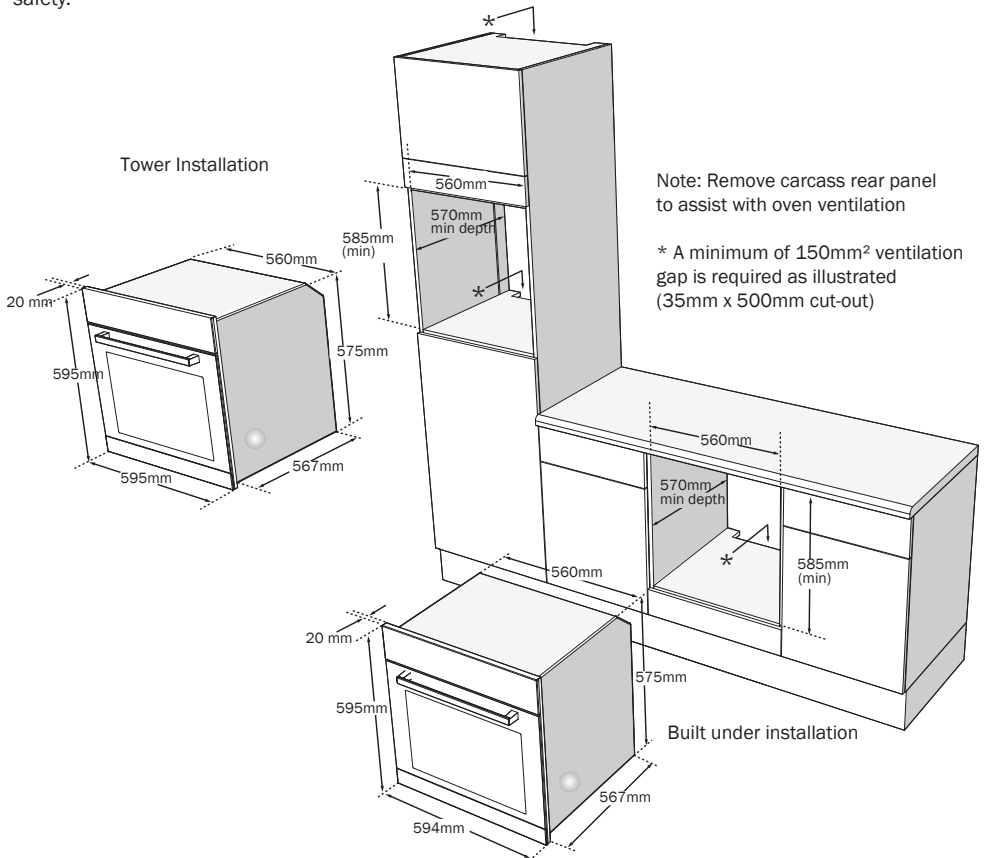

Electrical Connections



IMPORTANT: Ensure that the electricity supply is switched off before connecting. Your oven is intended for permanent installation.

Your appliance must be connected to fixed wiring via the use of a double pole switched fused spur outlet with at least 3mm contact separation. The isolation switch must be accessible after installation (see technical data for fuse rating). We recommend the use of an RCD device as additional protection.

We strongly recommend the appliance is connected by a qualified electrician who is a member of the N.I.C.E.I.C who will comply with the I.E.E and any local regulations.

The terminology DOUBLE POLE -/+ means that both the live and neutral supplies are switched and disconnected at the same time.

The terminations labelled SUPPLY are connections for the internal house wiring and the terminations labelled LOAD are for connection to the appliance.

IMPORTANT: The wires in the mains lead are coloured in accordance with the following code:-

Blue..... Neutral

Brown.....Live

Green and Yellow.....Earth

As the colours of the wires in the mains lead of this appliance may not correspond with the coloured markings identifying the terminals in your spur box, proceed as follows;

The wire which is coloured blue must be connected to the terminal which is marked with the letter 'N' or coloured 'BLACK'. The wire which coloured brown must be connected to the terminal which is marked with the letter 'L' or coloured RED. The green and yellow earth 'E' should be connected to the terminal marked with the following symbol '⊕'

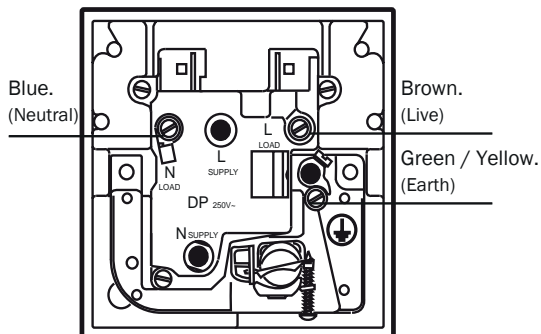

The appliance may be connected to the mains supply only by a competent person. The mains lead must not be clamped, bent, trapped, or come into contact with hot parts of the appliance.



If the mains lead is damaged, it must be replaced by a qualified person (mains cable must not be longer than 2m for safety reasons). It should be routed away from the appliance and not trapped between the appliance and the wall.

Your oven comes prefitted with a mains cable.
If you need to change it:

1. Open the terminal block cover with screwdriver.
2. Pass the mains lead under the cable clamp and secure clamp with the screw over the outer cable insulation.
3. Connect the cables according to the supplied diagram.
4. Close the cover of the terminal block once the wiring is complete.
5. Mains cable must not be longer than 2 metres for safety reasons.
6. The mains lead should be routed away from the appliance and not be trapped between the appliance and the wall.

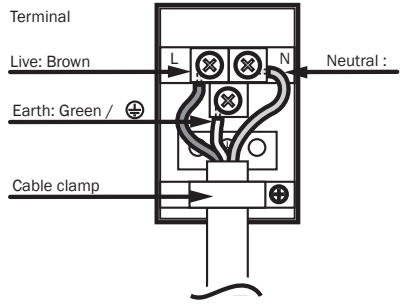

Installation

Slide the oven into the cabinet aperture, align and secure.

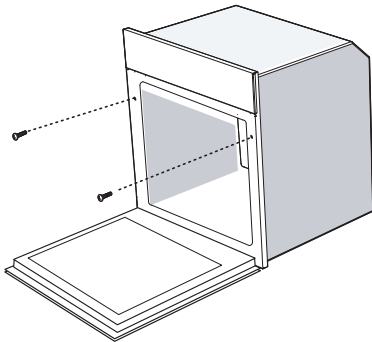

Fix your oven with 4 screws and retainers.

Final check

Connect the appliance to the mains supply, switch on the mains supply and check the oven's functions,

Cooling fan

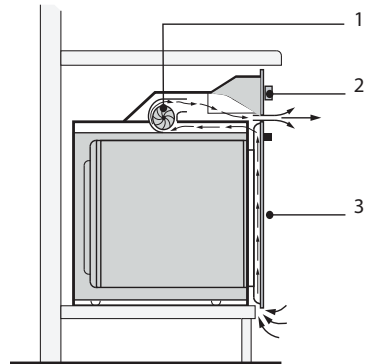

- 1- Fan
- 2- Control panel
- 3- Door

The Built-in cooling fan cools both the front of the appliance and cabinetry.



Do not switch the oven off at the mains isolation switch immediately after cooking. Cooling fan continues to run for up to 20-30 minutes (approx) even after the oven control is turned off.

Technical specification

TECHNICAL INFORMATION

General

Voltage /Frequency	220-240 V ~ 50 Hz
Total power consumption	2020 - 2400 W
Fuse	min. 13A

Oven/Grill

External dimensions (height / width / depth)	595 mm/594 mm/567mm
Installation dimensions (height / width / depth)	585-595 mm/560 mm/min. 570mm

Main oven

Energy efficiency class#

Energy consumption

Inner lamp

Mains Cable

Multi-Function Oven

A

Fan 0.79 kW/h

Conventional 0.88 kW/h

240 V/15-25 W/E14 SES/T 300 °C

H05VV-F 1.5mm² 3 Core (1.4m)

Basics: Information on the energy label of electrical ovens is given in accordance with the EN 60350-1 / IEC 60350-1 standard. Those values are determined under standard load with bottom-top heater or fan assisted heating (if any) functions.

Energy efficiency class is determined in accordance with the following prioritization depending on whether the relevant functions exist on the product or not. 1-Cooking with eco-fan, 2- Turbo slow cooking, 3- Turbo cooking, 4- Fan assisted bottom/top heating, 5-Top and bottom heating.

** See. Installation section.

- Technical specifications may be changed without prior notice to improve the quality of the product.
- Figures in this manual are schematic and may not exactly match your product.
- Values stated on the product labels or in the documentation accompanying it are obtained in laboratory conditions in accordance with relevant standards. Depending on operational and environmental conditions of the product, these values may vary.

Troubleshooting

TROUBLESHOOTING GUIDE

Symptoms	Possible Cause	Solutions
Oven emits steam when it is in use.	<ul style="list-style-type: none"> Food is being cooked with a high water content 	It is normal that steam escapes from food during cooking. This is not a fault.
Product emits metal noises while heating and cooling.	<ul style="list-style-type: none"> When the oven cavity heats up or cools down parts will expand and contract. 	This is quite normal and the oven is designed to accommodate such movement (this is not a fault).
Product does not operate	<ul style="list-style-type: none"> The mains fuse maybe defective or has tripped Product is not connected properly. Check all power connections. 	Check fuses in the fuse box. If necessary, replace or reset them.
Oven light does not work.	<ul style="list-style-type: none"> Oven bulb is defective Replace oven bulb Power is cut. 	Check if there is power. Check the fuses in the fuse box. If necessary, replace or reset the fuses.
Oven does not heat.	<ul style="list-style-type: none"> Function and/or Temperature are not set. The timer is not adjusted correctly Reset the oven timer. Power is cut. 	Set the function and the temperature with the Function and/or Temperature knob/key. Check if there is power. Check the fuses in the fuse box. If necessary, replace or reset the fuses.



If you cannot eliminate the problem after following the instructions in this section, consult your depot or the Authorized Service Agent. Never try to repair a nonfunctional product yourself.

Your guarantee

Product Guarantee Details (UK only)

Your appliance has the benefit of a comprehensive manufacturer's guarantee which covers the cost of breakdown repairs. (Details of which are shown on your Proof of purchase Document).

- Any claim during the period of the guarantee MUST BE ACCOMPANIED BY THE PROOF OF PURCHASE.
- The product must be correctly installed and operated in accordance with the manufacturer's instructions and used for normal domestic purposes.
- This guarantee does not cover accidental damage, misuse or alterations which are likely to affect the product.
- The guarantee is invalid if the product is tampered with, or repaired by any unauthorised person.

(The guarantee in no way affects your statutory or legal right)

What to do if you need to report a problem.

Please ensure you have ready:

- The product's model and serial numbers.
- Howdens Proof of Purchase Document.
- Your full contact details.

Call the Depot number on your Proof of Purchase Document supplied with the product / kitchen.

or

Call the LAMONA Service Line on 0845 00 60 006

*Product installed within a domestic kitchen or a non-domestic kitchen where 8 or fewer people are using the appliance.

<p>Where to find the model and serial number on your machine.</p>	<p>Open door on panel just below door seal.</p>
--	--

PRODUCT FICHE		
Energy Label Directive EU2010/30/EU-No65/2014 of ovens		
Brand	LAMONA	
Model	LAM3601	
Energy Efficiency Index per cavity EEI cavity	93.1	
Energy efficiency class	A	
Energy consumption (kWh)-Conventional per cycle (1)	0.88	
Energy consumption (kWh)-Forced air convection per cycle (1)	0.79	
Usable volume (litres)	71	
Number of cavity	1.0	
Heat source per cavity	Electrical	x
	Gas	
	Mix	

INSTRUCTION BOOKLET		
PRODUCT INFORMATION		
Comply with EU directive 2009/125/EC – Regulation No 66/2014		
Brand	LAMONA	
Model	LAM3601	
Type of oven	Free Standing	
	Built-in	x
Mass of the appliance(M) (Net Weight) kg	33.3	
Number of cavity	1.0	
Heat source per cavity	Electrical	x
	Gas	
	Mix	
Usable volume (litres)	71	
Energy consumption (electricity) required to heat a standardised load in a cavity of an electric heated oven during a cycle in conventional mode per cavity(kWh/cycle)(electric final energy) EC electric cavity	0.88	
Energy consumption required to heat a standardised load in a cavity of an electric heated oven during a cycle in fan-forced mode per cavity(kWh/cycle)(electric final energy) EC electric cavity	0.79	
Energy consumption required to heat a standardised load in a gas-fired cavity of an oven during a cycle in conventional mode per cavity (MJ/cycle) (kWh/cycle)(gas final energy) EC gas cavity (1)		
Energy consumption required to heat a standardised load in a gas-fired cavity of an oven during a cycle in fan-forced mode per cavity (MJ/cycle) (kWh/cycle)(gas final energy) EC gas cavity (1)		
Energy Efficiency Index per cavity EEI cavity	93.1	
(1) 1 kWh/cycle = 3,6 MJ/cycle.		

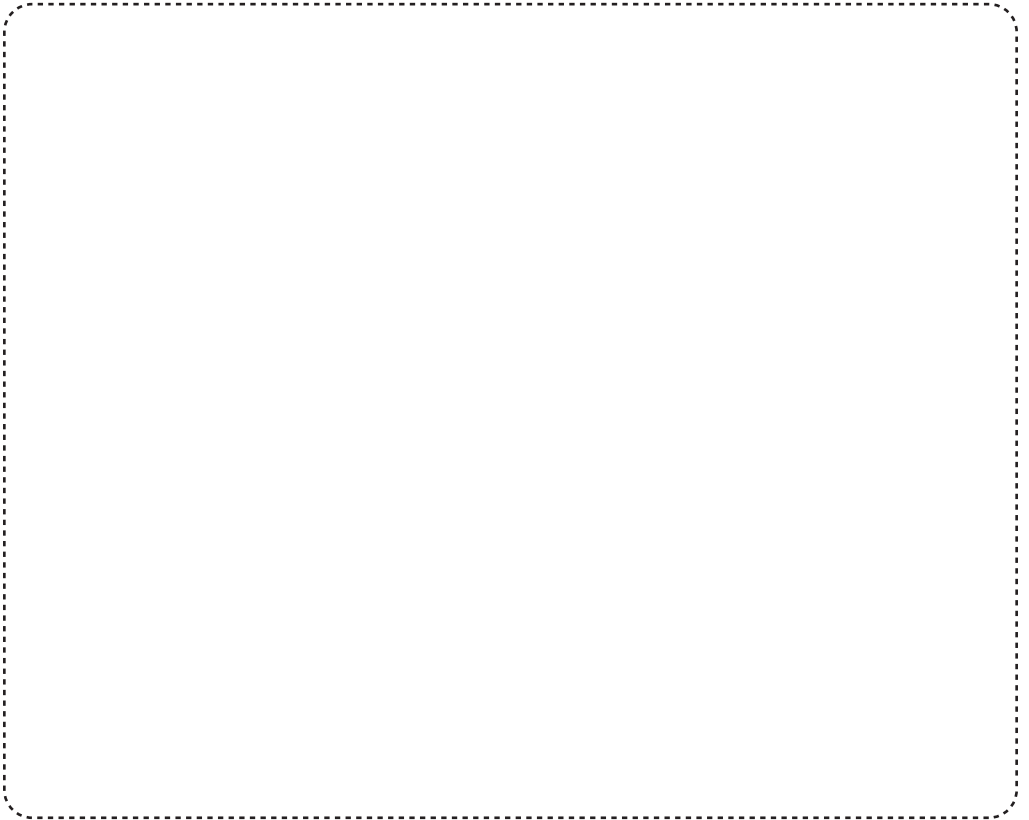

Product serial number
(Place sticker here)

LAMONA
Exclusive to Howdens Joinery Co.